



TFA SCOUTED

U20
SPECIAL
EDITION
**WORLD
CUP**

**THE TOP 21
TALENTS
SCOUTED
BY TFA IN
ARGENTINA**

JUNE 2023



TABLE OF CONTENTS



6 // JORGE CABEZAS // INDEPENDIENTE MEDELLÍN	104 // OSCAR CORTÉS // MILLONARIOS
15 // ARQUÍMIDES ORDÓÑEZ // CINCINNATI	114 // MATÍAS ABALDO // DEFENSOR
24 // SEYDOU SANO // US GORÉE	124 // ALEJO VÉLIZ // CA ROSARIO CENTRAL
32 // KEVIN MANTILLA // INDEPENDIENTE SANTA FE	136 // AGUSTÍN GIAY // SAN LORENZO
42 // BRIAN AGUIRRE // NEWELL'S OLD BOYS	148 // FÉLIX NZOUANGO // JUVENTUS NEXT GEN
53 // NAOKI KUMATA // FC TOKYO	160 // JI-SOO KIM // SEONGNAM
62 // LEO SAUER // FEYENOORD U21	170 // SEUNG-WON LEE // GANGWON FC
71 // TIMOTEJ JAMBOR // MSK ZILINA	179 // SEONG-JIN KANG // FC SEOUL
82 // KODAI SANO // FAGIANO OKAYAMA	191 // ILAY MADMON // BEITAR JERUSALEM
94 // FRANCO GONZÁLEZ // DANUBIO FC	203 // CALEB WILEY // ATALANTA UNITED FC
215 // RIKU YAMANE // YOKOHAMA F. MARINOS	



DEAR READER

WELCOME TO THE FIRST SPECIAL EDITION TFA SCOUTED MAGAZINE.

WHEN WE STARTED DOING THIS SECOND MONTHLY TFA MAGAZINE, WE WANTED TO SHOW OFF AS MUCH OF THE UNDER-THE-RADAR TALENT OUR VIDEO SCOUTING TEAM HAD UNCOVERED AS POSSIBLE.

USUALLY, OUR APPROACH IS TO USE OUR VARIOUS XGOLD DATA TOOLS TO POINT US IN THE RIGHT DIRECTION – BUT FOR THIS FIFA WORLD CUP U20 EDITION WE ARE VERY MUCH RELYING ON WHAT OUR EYES TOLD US.

IN THIS MONTH'S TFA SCOUTED, YOU WILL FIND 21 PLAYERS THAT WE HAVE IDENTIFIED AS BEING WHAT WE CONSIDER NON-OBVIOUS – MEANING, THEY MAY NOT HAVE BEEN THE PLAYERS THAT EYES WERE IMMEDIATELY DRAWN TO BUT WE FEEL STILL HAVE A LOT OF POTENTIAL AND SMART PEOPLE SHOULD BE AWARE OF.

THEN, USING OUR VARIOUS CUSTOM-BUILT XGOLD TOOLS IN ADDITION TO OUR VIZ ENGINE, WE VISUALISE MANY ELEMENTS OF EACH PLAYER'S GAME BEFORE USING OUR XGOLD TEAMFIT TOOL TO SUGGEST WHICH CLUBS THEY WOULD FIT (BASED ON OUR TIPSTER MODEL TIER SCORE – AND THERE MIGHT BE ONE OR TWO PLAYERS WHERE WE'VE HAD TO GO OLD SCHOOL AND MAKE SOME HUMAN-DRIVEN PREDICTIONS DUE TO THE LACK OF DATA!).

HOW DO WE DO THAT? WELL, XGOLD TAKES THE PLAYER DATA AND SEARCHES ALL THE TEAM DATA USING SOME ALGORITHMS BUILT BY SATHISH AND PROPOSES THE “BEST FITS” – WE THEN SANITY CHECK WHETHER IT IS TELLING THE TRUTH, ADD SOME EXTRA ELEMENTS OF CONTEXT TO IT ALL AND VOILA!

OVER THE NEXT FEW MONTHS, YOU WILL SEE THIS TFA SCOUTED MAGAZINE EVOLVE INTO SOMETHING THAT USES THE FULL RANGE OF XGOLD TOOLS – SOMETHING WE FEEL WILL MAKE THE SCOUTING AND READING EXPERIENCE EVEN BETTER FOR YOU, OUR LOYAL MEMBERS.

SO, PLEASE DO ENJOY THIS SPECIAL EDITION – AND IF YOU HAVEN'T ALREADY, GRAB THE UEFA U21 CHAMPIONSHIPS TACTICAL PREVIEW MAGAZINE AND MARK JULY 1ST ON THE CALENDAR AS THE DAY YOU'LL BE ABLE TO GET YOUR HANDS ON THE FIFA WOMEN'S WORLD CUP 2023 TACTICAL PREVIEW MAGAZINE TOO...

THANKS FOR SUPPORTING US, WITHOUT SUCH A LOYAL MEMBERSHIP WE WOULDN'T BE ABLE TO DO ANY OF THIS.

CHRIS

U20 WORLD CUP

- FIXTURES AND RESULTS -

GROUP STAGES

GUATEMALA 0-1 NEW ZEALAND
ARGENTINA 2-1 UZBEKISTAN
USA 1-0 ECUADOR
FIJI 0-4 SLOVAKIA
NIGERIA 2-1 DOMINICAN REP.
ITALY 3-2 BRAZIL
ISRAEL 1-2 COLOMBIA
SENEGAL 0-1 JAPAN
FRANCE 1-2 SOUTH KOREA
GAMBIA 2-1 HONDURAS
ENGLAND 1-0 TUNISIA
URUGUAY 4-0 IRAQ

USA 3-0 FIJI
ECUADOR 2-1 SLOVAKIA
UZBEKISTAN 2-2 NEW ZEALAND
ARGENTINA 3-0 GUATEMALA
SENEGAL 1-1 ISRAEL
JAPAN 1-2 COLOMBIA
ITALY 0-2 NIGERIA
BRAZIL 6-0 DOMINICAN REP.
URUGUAY 2-3 ENGLAND
IRAQ 0-3 TUNISIA
FRANCE 1-2 GAMBIA
SOUTH KOREA 2-2 HONDURAS

SLOVAKIA 0-2 USA
NEW ZEALAND 0-5 ARGENTINA
ECUADOR 9-0 FIJI
UZBEKISTAN 2-0 GUATEMALA
BRAZIL 2-0 NIGERIA
JAPAN 1-2 ISRAEL
DOMINICAN REP. 0-3 ITALY
COLOMBIA 1-1 SENEGAL
IRAQ 0-0 ENGLAND
SOUTH KOREA 0-0 GAMBIA
TUNISIA 0-1 URUGUAY
HONDURAS 1-3 FRANCE

ROUND OF 16

USA 4-0 NEW ZEALAND
UZBEKISTAN 0-1 ISRAEL
COLOMBIA 5-1 SLOVAKIA

BRAZIL 4-1 TUNISIA
ARGENTINA 0-2 NIGERIA
ENGLAND 1-2 ITALY

GAMBIA 0-1 URUGUAY
ECUADOR 2-3 SOUTH KOREA

QUARTER FINALS

ISRAEL 3-2 BRAZIL
COLOMBIA 1-3 ITALY
SOUTH KOREA 1-0 NIGERIA
USA 0-2 URUGUAY

SEMI FINALS

URUGUAY 1-0 ISRAEL
ITALY 2-1 SOUTH KOREA

BRONZE MEDAL

ISRAEL 3-1 SOUTH KOREA

FINAL

URUGUAY 1-0 ITALY

TIERS

Tier 1

England–Premier League–1
France–Ligue 1–1
Italy–Serie A–1
Spain–La Liga–1
Germany–Bundesliga–1

Tier 2

England–Championship–2
Russia–Premier League–1
Portugal–Primeira Liga–1
Turkey–Super Lig–1
Argentina–Supertiga–1
Brazil–Serie A–1
Belgium–First Division A–1
Netherlands–Eredivisie–1

Tier 3

Mexico–Liga MX–1
Czech Republic–Fortuna Liga–1
Denmark–Supertiga–1
Greece–Super League 1–1
Sweden–Allsvenskan–1
Switzerland–Super League–1
Ukraine–Vbet Liga–1

Tier 4

Scotland–Premiership–1
Spain–Segunda Division–2
Germany–2. Bundesliga–2
USA–MLS_1
Colombia–Liga BetPlay–1
Ecuador–Liga Pro–1
Uruguay–Primera Division–1
Japan–J1 League–1
Austria–Bundesliga–1
Croatia–1 HNL–1
Hungary–NB1–1
Norway–Eliteserien–1
Poland–Ekstraklasa–1
Romania–Liga 1–1

Tier 5

Italy–Serie B–2
France–Ligue 2–2
Paraguay–Division Profesional–1
Qatar–ONB Stars League–1
Saudi Arabia–Pro League–1
Bulgaria–First League–1
Cyprus–1 Division–1
Israel–Ligat ha'Al–1
Serbia–Superliga–1

Tier 6

England–League 1–3
Germany–3. Liga–3
Netherlands–Eerste Divisie–2
Portugal–Segunda Liga–2
Turkey–1. Lig–2
Argentina–Prim B Nacional–2
Brazil–Serie B–2
Bolivia–LFPB–1
Chile–Primera Division–1
Costa Rica–Primera Division–1
Honduras–Liga Nacional–1
Peru–Primera Division–1
Venezuela–Primera Division–1
Australia–A League–1
Egypt–Premier League–1
Morocco–Botola Pro–1
Belarus–Premier League–1
Slovakia–Supertiga–1
Switzerland–Challenge League–2
Belgium–First Division B–2
Algeria–Ligue 1–1
Canada–Canadian Premier League–1
Greece–Super League 2–2
Iran–Persian Gulf Pro League–1
South Africa–PSL–1
Slovakia–Supertiga–1
Spain – Primera RFEF–3

Tier 7

England–League 2–4
Scotland–Championship–2
Italy–Serie C–3
France–National 1–3
Russia–Football National League–2
China–CSL–1
UAE–Arabian Gulf League–1
Azerbaijan–Premyer Liga–1
Bosnia & Herzegovina–1
Denmark–1st Division–2
Finland–Veikkausliiga–1
Kazakhstan–Premier League–1
Norway–OBOS ligaen–2
Slovenia–1 SNL–1
Sweden–Superettan–2
Ukraine–Persha Liga–2
Croatia–2. HNL–2
Finland–Ykkonen–2
Georgia–Erovnuli Liga 2–2
Japan–J2 League–2
Mexico–Liga de Expansion–2
Moldova–Divizia Nationala–1
North Macedonia–First League–1
Poland–1 Liga–2
Portugal–Campeonato de Portugal–3
Republic of Ireland–1
Spain–Segunda Division RFEF–4
Tunisia–Ligue 1–1
Uzbekistan–Super League–1
Iceland_Urvalsdeild karla–1

Tier 8

Germany–Regionalliga–4
India–Indian Super League–1
Korea–K League 1–1
Albania–Superliga–1
Armenia–Premier League–1
Austria–2. Liga–2
Georgia–Erovnuli Liga–1
Latvia–Virisliga–1
Lithuania–Vysa Liga–1
Montenegro–First League–1
Argentina–Primera Metropolitana–3
Belgium–National Division 1–3
Brazil–Serie C–3
Chile–Primera B–2
Colombia–Torneo BetPlay–2
El Salvador–Primera Division–1
France–National 2–4
Guatemala–Liga Nacional–1
India–1 League–2
Israel–Liga Leumit–2
Italy–Serie D–4
Netherlands–Tweede Divisie–3
New Zealand–Premiership–1
Northern Ireland–Premiership–1
Panama–LPF–1
Peru–Segunda Division–2
Scotland–League 1–3
Singapore–Premier League–1
Sweden–Ettan–3
Ukraine–Druha Liga–3
Uruguay–Segunda Division–2
USA–USL Championship–2
Vietnam–VLeague 1–1
China–League 1–2

Tier 9

England–National League–5
USA–USL League One–3
Korea–K League 2–2
Czech Republic–FL–2
Estonia–Meistriliiga–1
Hungary–NB2–2
Poland–2 Liga–3
Serbia–Prva Liga–2
Belarus–1 Division–2
Brazil–Serie D–4
Bulgaria–Second League–2
Hong kong–Premier League–1
Iceland–1 deild karla–2
Indonesia–Liga 1–1
Italy–Primavera 1 youth–5
Italy–Primavera 2 youth–6
Malaysia–Super League–1
Malta–Premier League–1
Nicaragua–Primera Division–1
Republic of Ireland–First Division–2
Scotland–League 2–4
Thailand–Thai League 2–2



INDEPENDIENTE
MEDELLÍN



COLOMBIA

SCOUT REPORT

JORGE CABEZAS

JUNE 2023



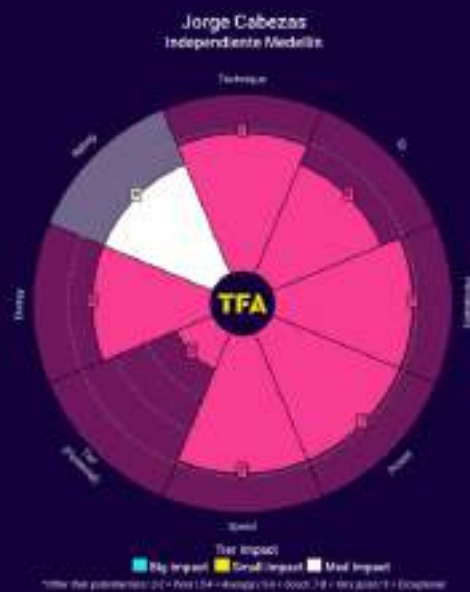

Jorge Cabezas, at 19 years of age, is a centre-forward who stands out for his power and speed to make unmarked moves or attack space. He is also a tall and strong player, so he often wins duels and can hold opponents at his back or dominate in the air to be used as a target-man.

He is energetic and often makes intense efforts to dynamise attacks or win the ball back. In addition, he is able to adapt to different approaches to the game, working with great discipline in every phase of the game.

Due to his age and potential, Jorge Cabezas has the level to continue his career in a Tier 2 league, especially in a team where he can develop his talent.

T - Technique I - IQ (football intelligence) P - Personality P - Power S - Speed T - Tier (potential Tier - see explainer) E - Energy
R - Rating (Big, Medium, Small) if he moved to that Tier today

Score explanations (other than potential tiers): 0-2 - poor 3-4 - average 5-6 - good 7-8 - very good 9 - exceptional

PLAYER PROFILE

Jorge Cabezas is a 19-year-old (06/09/2003) centre-forward. He's left-footed.

The Colombian is currently playing for Independiente Medellín in the Liga Dimayor, Colombia's top tier.

Cabezas is a very powerful centre-forward, who can win duels frequently and gains a lot of advantages in attacking space and in his general unmarking moves.

He has played 19 games for the Colombia U20 national team.

His current value on Transfermarkt is €700,000.

PLAYER HISTORY

Jorge Cabezas started his career at Real Cartagena. In January 2023, he was signed by Watford and immediately loaned to Independiente Medellín, his current club.

J. CABEZAS HURTADO HEATMAP

All games from Sudamericano U20 2023 Colombia, Liga BetPlay 2023, Copa Libertadores 2023

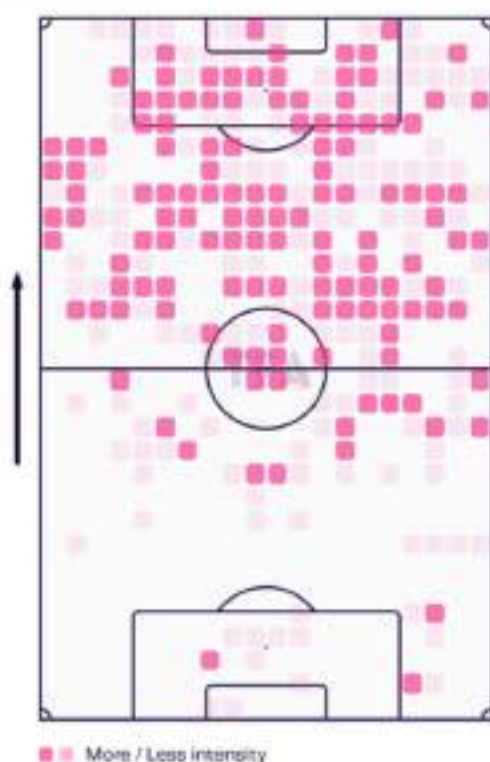

DEFENSIVE PHASE

Jorge Cabezas is a player who works with a lot of intensity and intelligence in the defensive phase of the game. He makes runs with a lot of speed and shows good defensive concepts to reduce the opposition's options for progression as much as possible, making him an ideal profile to press high.

However, he is also a player with good scanning of his zone who can drop back and work in a coordinated way in a mid-low block, more focused on drawing the opponent and covering passing lines so that he cannot progress without taking too many risks.

He is able to adapt to multiple off-the-ball ideas and be useful in each of them. In addition, he has the energy to always be active in retrieving the ball in different areas of the pitch.

J. CABEZAS HURTADO DEFENSIVE TERRITORY

All games from Copa Libertadores 2023, Liga BetPlay 2023, Sudamericano U20 2023 Colombia



J. CABEZAS HURTADO HIGH REGAINS

All games from Copa Libertadores 2023, Liga BetPlay 2023, Sudamericano U20 2023 Colombia



ATTACKING PHASE

Jorge Cabezas is a centre-forward who stands out for his power and speed. He can be very useful as a target-man, as he uses excellent body positions to hold opponents behind him and is dominant in the air.

He has very powerful unmarking movements, achieving great advantages through his stride, and he is intelligent in knowing which areas of the pitch to move to in order to create passing lanes or attack space and dynamise plays or directly finish dangerous plays.

His finishing is positive. He is a player with a very powerful and well-directed shot. In addition, he can use both feet very fluently. He could continue to work on the types of finishing he dominates.

He is able to adapt to different ideas of play, as he makes very intelligent efforts and has good reading which allows him to make very good off-the-ball decisions. Able to play as a single CF or also in a system with two strikers.

J. CABEZAS HURTADO SHOTS

All games from Copa Libertadores 2023, Liga BetPlay 2023, Sudamericano U20 2023 Colombia



J. CABEZAS HURTADO SHOT ASSISTS

All games from Copa Libertadores 2023, Liga BetPlay 2023, Sudamericano U20 2023 Colombia



J. CABEZAS HURTADO PASS MAP

All games from Copa Libertadores 2023, Liga BetPlay 2023, Sudamericano U20 2023 Colombia



J. CABEZAS HURTADO PROGRESSIVE PASSES

All games from Copa Libertadores 2023, Liga BetPlay 2023, Sudamericano U20 2023 Colombia



J. CABEZAS HURTADO PENETRATING CARRIES

All games from Copa Libertadores 2023, Liga BetPlay 2023, Sudamericano U20 2023 Colombia

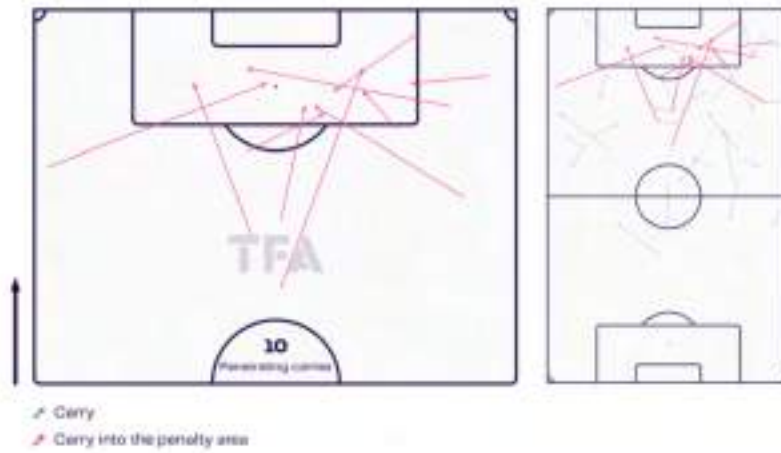

TRANSITIONS

In the attacking transitions, Cabezas is a very powerful player for attacking space - he can make unmarked moves to energise possessions, but also focus on attacking space or directly into the box to finish.

In the defensive transitions, he is a player who can adapt to multiple off-the-ball approaches, as he works hard to press high, but also knows how to drop back to block passing lanes or draw the opposition in.

J. CABEZAS HURTADO BALL PROGRESSION

All games from Copa Libertadores 2023, Liga BetPlay 2023, Sudamericano U20 2023 Colombia



PHYSICAL PROFILE

Jorge Cabezas is left-footed, listed at 185cm.

He is a strong and powerful player. He gets a lot of advantage in duels and aerial play. However, he is also a player with a lot of pace to attack space and get away from centre-backs.

Despite being a tall, long-limbed player, his movements are coordinated and he has a good technique for controlling, changing direction and finishing.

CLUB MATCHING METHODOLOGY

Our custom-built xGOLD tool has the ability to match players to clubs from a data-driven tactical fit perspective - we then take the initial shortlist and go into further scout-led filtering, considering the key points below.

A) Playing Style

Assessing teams by their playing style and finding a suitable match for Cabezas: progressive teams that can activate him into space frequently.

B) Leagues

We are looking at options at teams in Argentina, Portugal and Belgium.

C) Statistics

Players statistically similar to Jorge Cabezas and whose contracts are ending and he could replace.

Argentina Liga Profesional

Racing Club

- Maximiliano Romero is on loan at the club, while Hauche and Guerrero's contracts expire in 2023.
- Ideal club to adapt to a context of maximum demand where he could develop his talent in a very competitive league.
- They have averaged 74.45 progressive passes p/90.

CA Talleres

- Nahuel Bustos is on loan at the club.
- Team that gives many opportunities to young talents and where he could be boosted by the game idea.
- They have averaged 66.01 progressive passes p/90.

Boca Juniors

- Miguel Merentiel is on loan at the club and Luis Vázquez could leave in the short term.
- This is a highly demanding context where he could aspire to play a good amount of minutes in order to continue his development.
- His self-sufficiency would be of great use in the playing style.
- They have averaged 62.75 progressive passes p/90.

Portugal Primeira Liga

Gil Vicente FC

- Fran Navarro is likely to be sold in the summer
- Cabezas could adapt very well to the dynamics of the team due to his self-sufficiency and power.
- They have averaged 64.65 progressive passes p/90.

GD Estoril Praia

- Joao Carlos and Alejandro Marqués are on loan at the club.
- Cassiano is already 33 years old.
- Cabezas could have a very positive impact in the short term and boost the team's offensive dynamics.
- They have averaged 53.07 progressive passes p/90.

Boavista

- Robert Bozenik is on loan and Jorge Cabezas could be an ideal replacement, as he can perform the same functions.
- Ideal club to play a good amount of minutes and continue to develop his game.
- They have averaged 58.29 progressive passes p/90.

Belgium Jupiler Pro League

KRC Genk

- Only two strikers in the squad.
- Ally Samatta is on loan from Fenerbahçe.
- One of the most competitive clubs in the country where he could adapt to the highest demands.
- They have averaged 72.00 progressive passes p/90.

KAA Gent

- Gift Orban is likely to be sold in the summer.
- Cabezas is a CF who stands out for his power and could keep the team's attacking dynamics up.
- Ideal league to enhance his development.
- They have averaged 77.44 progressive passes p/90.

KVC Westerlo

- Jorge Cabezas could have similar roles to those that Lyle Foster had at the team.
- Ideal club to play a good amount of minutes in the short term and continue to polish the details of his game.
- They have averaged 70.99 progressive passes p/90.



FC CINCINNATI



GUATEMALA

ARQUÍMIDES ORDÓÑEZ

SCOUT REPORT

JUNE 2023



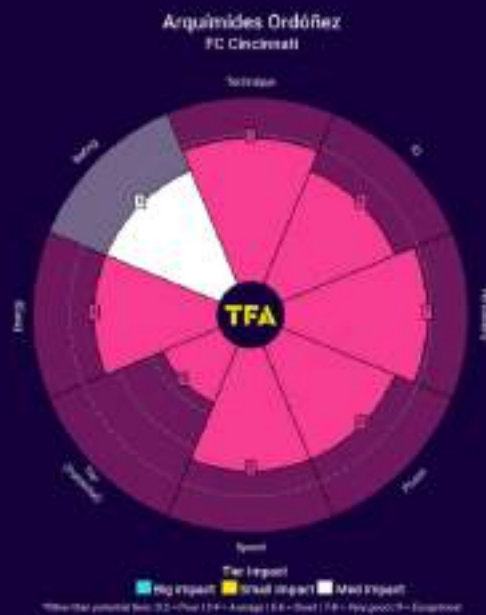

Arquimides Ordóñez, at 19 years of age, can play as a CF or SS/AMF. He is a player with very good technical-creative attributes, who can create and finish scoring chances very fluently. In addition, his associative intentions are often very useful to dynamise his team's attacks or to activate teammates in space.

He is a player who can adapt to different roles, but especially stands out with his freedom to appear in the inside channels, receive, turn and create goal-scoring chances. He is agile and quick to exploit advantages.

Due to his age and potential, Arquimides Ordóñez could play in a Tier 3 league in the short/medium term. However, he must prioritise regularity at professional level in the coming months to further develop his game.

**T - Technique I - IQ (football intelligence) P - Personality P - Power S - Speed T - Tier (potential Tier - see explainer) E - Energy
R - Rating (Big, Medium, Small) if he moved to that Tier today**

Score explanations (other than potential tiers): 0-2 = poor 3-4 = average 5-6 = good 7-8 = very good 9 = exceptional

PLAYER PROFILE

Arquímides Ordóñez is a 19-year-old (05/08/2003) centre-forward. He's right-footed.

The Guatemalan-American is currently playing for FC Cincinnati in the MLS, United States' top tier.

Ordóñez is a player who stands out on a technical-creative level, can adapt to different roles and has a lot of intelligence to create or finish goal situations.

He has played 2 games for the Guatemala national team.

His current value on Transfermarkt is €400,000.

PLAYER HISTORY

Arquímides Ordóñez started his career at CLB Academy. Then, in the summer of 2019, he joined FC Cincinnati, his current team.

A. ORDÓÑEZ HEATMAP

All games from MLS Next Pro 2023, US Open Cup 2023, MLS 2023, CONCACAF U20 2022 Honduras

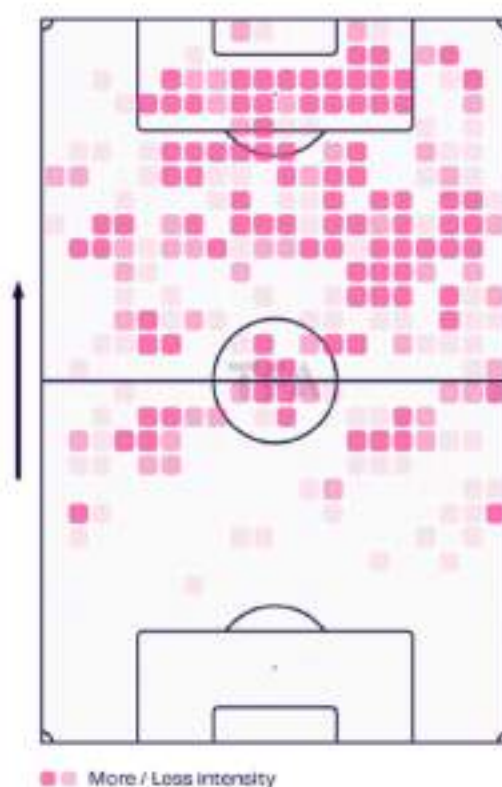

DEFENSIVE PHASE

Arquímides Ordóñez is a player who can work in coordination with the mid-low block to cover passing lanes and draw opponents in. He is not a player who stands out for his intensity to make great efforts in pressure and lead the front line.

However, he is a strong player with very good fundamentals to win duels and second balls. He uses his body very well and is able to displace his opponents with ease.

He could be provided with better defensive concepts to have a greater impact off-the-ball and be able to adapt better to different approaches.

A. ORDÓÑEZ DEFENSIVE TERRITORY

All games from MLS Next Pro 2023, US Open Cup 2023, MLS 2023, CONCACAF U20 2022
Honduras, MLS Next Pro 2022

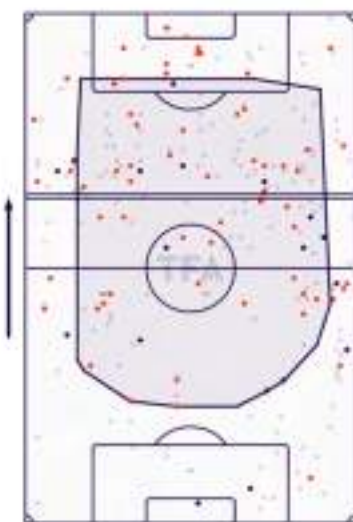

- Defensive action
- Interception
- Foul

A. ORDÓÑEZ HIGH REGAINS

All games from MLS Next Pro 2023, US Open Cup 2023, MLS 2023, CONCACAF U20 2022
Honduras, MLS Next Pro 2022



- Ball recovery
- Dangerous recovery (leading to a shot within 20 seconds)
- Counter-pressing recovery (within 5 seconds after a possession loss)

ATTACKING PHASE

Arquímides Ordóñez can play as CF or SS/AMF. He is a player with very good technical-tactical attributes to receive, change direction or turn and pass. Due to this, he can create passing lanes inside frequently, receive between the lines and generate or finish goal scoring chances very fluently.

He is a player who is at his best when he is free to move around, appear in different areas of the pitch and generate superiority or activate his team-mates in the spaces he creates, attracting markers so that they get out of position or neglect the opponents behind him.

He is very skilful at carrying the ball and finishing on the move, even using both feet. In a team that activates him frequently, with good passers behind him, he can exploit his finishing ability and score frequently. He is clever at reading the play and making unmarked moves, either to energise attacks or get into the box and finish in 1v1, where he has ideal composure to beat the goalkeeper.

A. ORDÓÑEZ SHOTS

All games from MLS Next Pro 2023, US Open Cup 2023, MLS 2023, CONCACAF U20 2022 Honduras, MLS Next Pro 2022

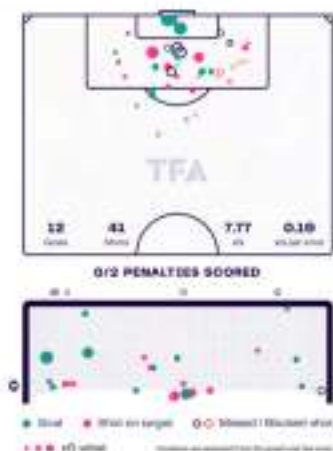

A. ORDÓÑEZ SHOT ASSISTS

All games from MLS Next Pro 2023, US Open Cup 2023, MLS 2023, CONCACAF U20 2022 Honduras, MLS Next Pro 2022



A. ORDÓÑEZ PASS MAP

All games from MLS Next Pro 2023, US Open Cup 2023, MLS 2023, CONCACAF U20 2022
Honduras



➤ Successful pass

A. ORDÓÑEZ PROGRESSIVE PASSES

All games from MLS Next Pro 2023, US Open Cup 2023, MLS 2023, CONCACAF U20 2022
Honduras, MLS Next Pro 2022



➤ Progressive pass
➤ Progressive pass into the penalty area

A. ORDÓÑEZ PENETRATING CARRIES

All games from MLS Next Pro 2023, US Open Cup 2023, MLS 2023, CONCACAF U20 2022
Honduras



➤ Carry
➤ Carry into the penalty area

TRANSITIONS

In the attacking transitions, Arquímedes Ordóñez is a very useful player for creating passing lanes and dynamising possessions. In addition, his mobility to attack space or the box and finish is very positive.

In the defensive transitions, he is a player who works in coordination with the block to cover passing lanes. He could be more intense in high pressure to be really effective in these efforts.

A. ORDÓÑEZ BALL PROGRESSION

All games from MLS Next Pro 2023, US Open Cup 2023, MLS 2023, CONCACAF U20 2022 Honduras, MLS Next Pro 2022



PHYSICAL PROFILE

Arquímedes Ordóñez is right-footed, listed at 188cm.

He is a very tall and powerful physical player. He uses his body very well to win duels and displace his opponents. However, he is also a player with good speed and agility to change direction or turn for on-ball advantages.

His movements are very coordinated and fluid, which even allows him to dribble frequently.

CLUB MATCHING METHODOLOGY

Our custom-built xGOLD tool has the ability to match players to clubs from a data-driven tactical fit perspective - we then take the initial shortlist and go into further scout-led filtering, considering the key points below.

A) Playing Style

Assessing teams by their playing style and finding a suitable match for Ordóñez: team where he can be free to move in attack and create or finish scoring chances.

B) Leagues

We are looking at options at teams in Mexico, Denmark and United States.

C) Statistics

Players statistically similar to Arquímedes Ordóñez and whose contracts are ending and he could replace.

Mexico Liga MX

CF Monterrey

- He could play as CF, SS or AMF, as he fits several roles in the system.
- Could have a good impact in the short term due to the fit with the style of play.
- Ideal club to adapt to a demanding context.
- They have averaged 64.86 progressive passes p/90.

Cruz Azul

- Michael Estrada and Gonzalo Carneiro are on loan at the club.
- He could exploit their mobility in the play idea to create or attack space and dynamise his team's possessions.
- Good fit in the squad.
- They have averaged 59.35 progressive passes p/90.

Club León

- Lucas Di Yorio, Brian Rubio and Alfonso Alvarado are on loan at the club.
- They will need to sign at least two strikers during the next transfer window.
- Ordóñez could adapt to a two-striker system where he has to move out of the zone frequently.
- They have averaged 59.5 progressive passes p/90.

Denmark Superligaen

FC Midtjylland

- Ideal club to further develop his game.
- He could fit in very well with the team's attacking dynamics due to his intelligence to move and dynamise possessions.
- They have averaged 67.37 progressive passes p/90.

FC Nordsjaelland

- Only two CFs in the squad.
- Wahid Faghir is on loan at the club.
- Arquímides Ordóñez could fit very well into the team's style of play.
- They have averaged 68.39 progressive passes p/90.

Viborg FF

- Several of the CFs in the squad could leave the club next summer.
- He could adapt to a variety of roles, but would fit very well as a CF with mobility to create and attack space.
- They have averaged 71.42 progressive passes p/90.

United States MLS

New York City FC

- Gabriel Segal is the only natural CF in the squad.
- They will need to sign at least two strikers urgently during the next transfer window.
- Ordóñez fits quite well into the game idea.
- They have averaged 61.2 progressive passes p/90.

FC Dallas

- Jesus Ferreira could be sold in the short term.
- Ideal club to further develop his talent while he accumulates valuable minutes.
- He could adapt to different systems and exploit his associative play and mobility between lines.
- They have averaged 63.77 progressive passes p/90.

Nashville SC

- Bunbury and Zubak are the only two CFs in the squad.
- Arquímides Ordóñez could adapt well to the system to be the striker with more mobility to attack space and dynamise the team's attacks.
- He could have a very positive impact in the short term.
- They have averaged 63.39 progressive passes p/90.



US GORÉE



SENEGAL

SCOUT REPORT

SEYDOU SANO

JUNE 2023



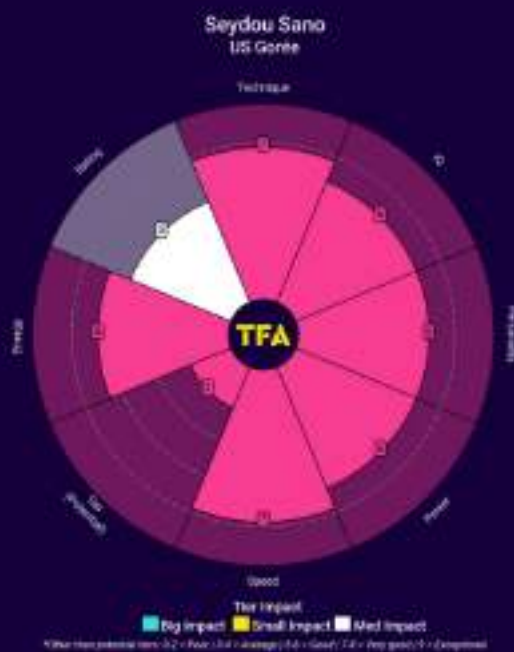

Seydou Sano, at 18 years of age, is a centre-back who stands out for his height and speed. In addition, unlike many equally tall CBs, he is a player with very good technical attributes and coordinated movements to be of great use in the attacking phase. Due to this, he is a player with great potential to be imposing in the overall game.

His passing range is especially good, dominating both feet and being very intelligent and aggressive in breaking lines of pressure. He could improve his decision making, but has well-developed concepts to allow his team to progress.

He is a centre-back who needs to continue to polish his game, but could have a positive impact at Tier 2 level in the short term, especially in teams with a good development system for this type of talent.

**T = Technique I = IQ (football intelligence) P = Personality P = Power S = Speed T = Tier (potential Tier - see explainer) E = Energy
 R = Rating (Big, Medium, Small) if he moved to that Tier today**

Score explanations (other than potential tiers): 0-2 = poor 3-4 = average 5-6 = good 7-8 = very good 9 = exceptional

PLAYER PROFILE

Seydou Sano is a 18-year-old (28/10/2004) centre-back. He's left-footed.

The Senegalese is currently playing for US Gorée in Senegal.

Sano is a ball-playing centre-back. He has a great passing range and takes risks to progress by breaking lines of pressure. In addition, he dominates both feet. He is also aggressive and powerful to get out of the zone and is an important asset in a high defence.

He has played 10 games for the Senegal U20 national team.

His current value on Transfermarkt is €150,000.

PLAYER HISTORY

Seydou Sano has played his entire career at US Gorée.

S. SANO HEATMAP

All games from Africa U20 Cup of Nations 2023 Egypt

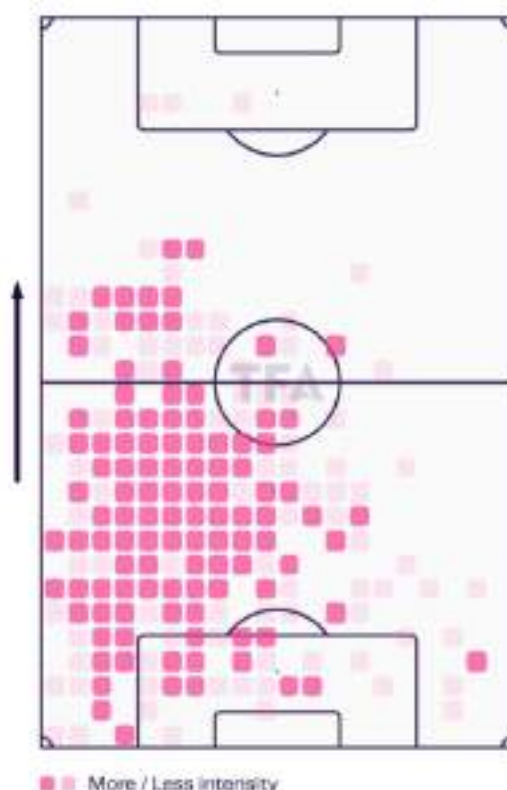

DEFENSIVE PHASE

Seydou Sano is a very powerful and aggressive centre-back. Due to his size and strength, he is a player who often manages to impose himself in duels and through aerial play, especially in youth tournaments. However, he needs to continue to develop his defensive concepts to adopt better body postures, be more stable and learn to control his opponents (basically prevent them from turning) without the need to anticipate them.

He is a smart player to get out of the zone and relieve his teammates. In addition, he has very good tackling technique to steal the ball frequently, as well as a long reach in his lower body that gives him power in 1v1.

Sano has ideal physical conditions to be a very imposing centre-back, but he must continue to develop his defensive concepts and regulate his aggressiveness to become a truly outstanding figure in the coming years.

S. SANO DEFENSIVE TERRITORY

All games from Africa U20 Cup of Nations 2023 Egypt

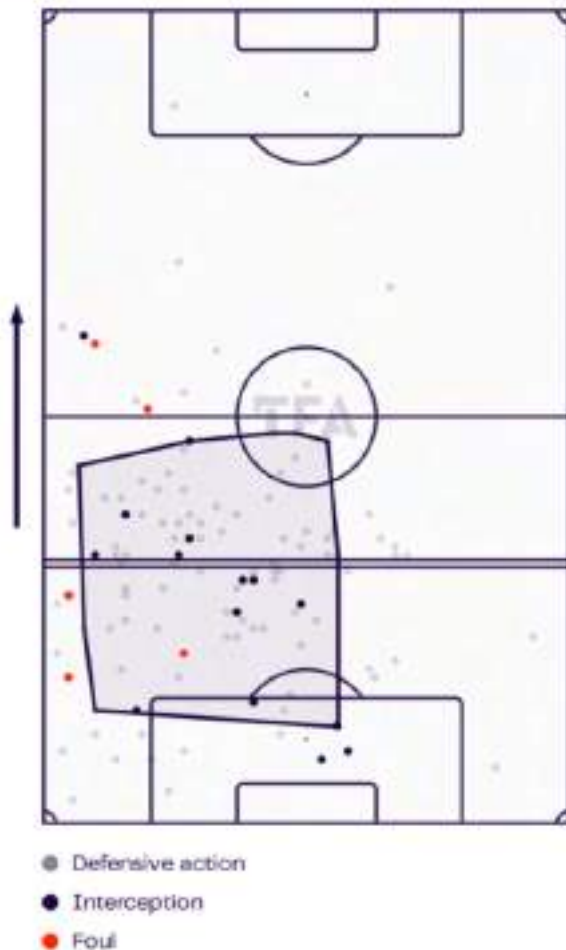

ATTACKING PHASE

Seydou Sano is a centre-back with very aggressive on-ball intentions. He has a great range of progressive passing and knows how to take risks to advance up the pitch - he dominates both feet, executes various types of passes to break the opposition's lines and is quick in his execution, both to spot the potential receiver and to connect with him.

He is also a very powerful ball-carrying CB. If he has metres to run or detects a big gap in the front lines of the opposing block, he can aggressively move forward and then connect with players in front of him. He has even shown a good mid-range shot, with plenty of power, which can be further developed in the future.

He is a player who could have a fit in a back three, especially as an LCB, so he can exploit his progressive passing range with lots of diagonal connections and have more space to get forward and accelerate attacks.

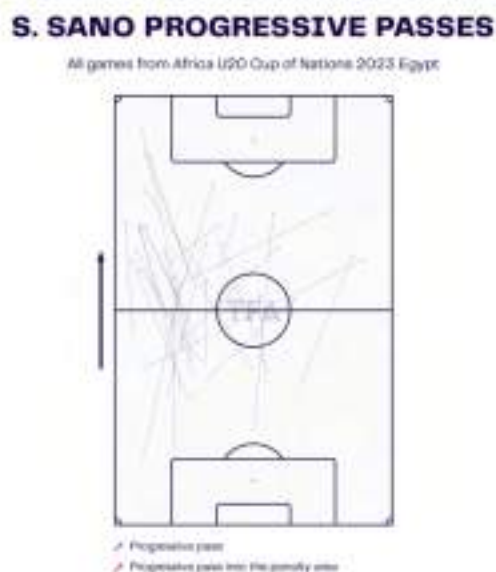
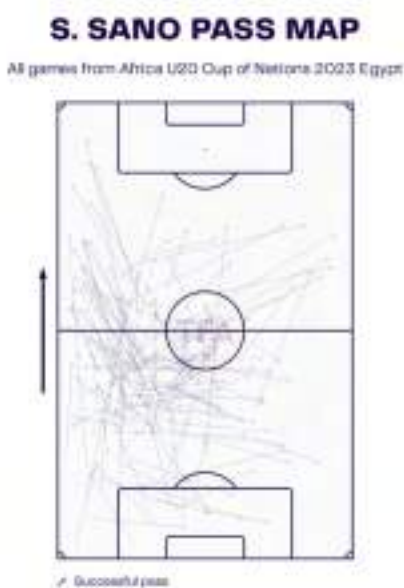

TRANSITIONS

In the attacking transitions, Sano is a very intelligent and aggressive centre-back to exploit his progressive passing range to create counter-attacks or link up with players in good areas to create scoring chances. He can also carry the ball with speed.

In the defensive transitions, he is a very aggressive player who could be of great use in high defences if he continues to develop his defensive concepts and build up his physicality. His intentions when dropping back to order a lower-mid block are positive.

S. SANO BALL PROGRESSION

All games from Africa U20 Cup of Nations 2023 Egypt



PHYSICAL PROFILE

Seydou Sano is left-footed, listed at 194cm.

He is a very tall and powerful physical player. He has developed musculature and this allows him to be very imposing in duels and aerial play, but he could be optimising his body to be stronger, more solid and balanced in physical contact.

He is a very technically skilled player. His movements are coordinated and quick, which allows him to defend large spaces at his back.

CLUB MATCHING METHODOLOGY

Our custom-built xGOLD tool has the ability to match players to clubs from a data-driven tactical fit perspective - we then take the initial shortlist and go into further scout-led filtering, considering the key points below.

A) Playing Style

Assessing teams by their playing style and finding a suitable match for Sano: very progressive teams that use their centre-backs to lead the first phase.

B) Leagues

We are looking at options at teams in Belgium, Portugal and Netherlands.

C) Statistics

Players statistically similar to Seydou Sano and whose contracts are ending and he could replace.

Portugal Primeira Liga

SC Braga

- One of the most aggressive teams moving forward in the league where his passing range could easily be exploited.
- Ideal club to adapt to a demanding context.
- League in which he could excel in the short to medium term.
- They have averaged 71.56 progressive passes p/90.

FC Famalicão

- Ideal club to develop the talents of promising young players.
- Idea of play in which their aggressive intentions to progress would be of great use.
- Queirós is out of contract and Otávio is on loan.
- They have averaged 59.43 progressive passes p/90.

Sporting CP

- One of the best clubs in Portugal with a great talent development system where he could develop his game.
- Luís Neto finishes his contract with the club.
- He could have a very good impact in the medium term.
- They have averaged 68.87 progressive passes p/90.

Belgium Jupiler Pro League

KVC Westerlo

- Great fit with the idea of the game.
- Could have a positive impact in the short term.
- Ravil Tagir is on loan at the club.
- They have averaged 70.99 progressive passes p/90.

Royal Antwerp

- Game idea that could enhance his main virtues on-ball to progress.
- William Pacho has been sold to Eintracht Frankfurt.
- Ideal club to further develop his talent.
- They have averaged 74.1 progressive passes p/90.

RSC Anderlecht

- Ideal club to continue polishing the details of his game within a philosophy capable of enhancing his talent.
- Delcroix could be sold in the short term and Vertonghen is 36 years old.
- They have averaged 68.06 progressive passes p/90.

Netherlands Eredivisie

PSV Eindhoven

- Only four centre-backs in the squad and one of them (Brantwaite) is on loan from Everton.
- Very aggressive approach to play and ideal for developing his passing range.
- Good context to further develop his talent.
- They have averaged 74.52 progressive passes p/90.

Twente FC

- Julio Pleguezuelo leaves the team.
- Only three centre-backs in the squad.
- He could play a good amount of minutes in the short/medium term and continue to develop his talent in an ideal league for that.
- They have averaged 71.01 progressive passes p/90.

Vitesse Arnhem

- Club that gives many opportunities to young talents.
- Ryan Flamingo is on loan at the club and Tomas Hajek is leaving, so they will need to sign centre-backs next summer.
- They have averaged 66.32 progressive passes p/90.



INDEPENDIENTE
SANTA FE



COLOMBIA

SCOUT REPORT

KEVIN MANTILLA

JUNE 2023



Kevin Mantilla

Santa Fe

Category	Description	Points
International Appearances	No data	0
Domestic Minutes	Band 4: 40%	1
Continental Minutes	No data	0
League Position	Santa Fe: Colombia Categoría Primera A - Band 2 Qualifiers	
Continental Progression	No data	0
League Quality	Liga BetPlay	6
Total	Ineligible	7

This calculation is based on rules agreed by the FA and the Home Office for players to play in England. There will be edge cases and different interpretations. Our Governing Body Endorsement (GBE) status tool should be used as a guide to assess the likelihood of a player meeting the criteria, rather than a definitive assessment. GBE criteria are regularly reviewed by the FA and Home Office. Any changes will be incorporated into our calculations when they are announced.

NB: Our calculations don't currently take into account injury data or, for players under 21, any additional points from the youth criteria. There are variations to the GBE criteria for players to play in Scotland and details can be found on the Scottish FA website.

TFA

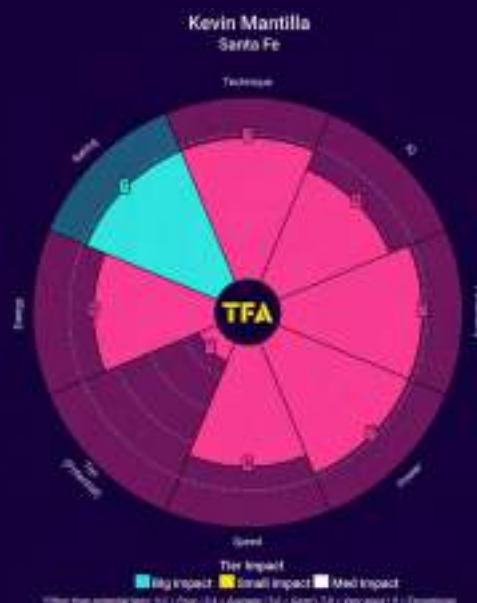

Kevin Mantilla is a 20-year-old centre-back who shows composure, maturity and physical attributes way beyond his years. He is very comfortable playing out from the back, can go long when required and also has the confidence to carry the ball out from defence while beating players 1v1. He is dominant in the air, bravely and aggressively challenging for aerial duels which allows him to defend crosses in his box as well as get headers on goal from attacking set pieces. He likes to get tight to his man but rarely makes rash decisions and is generally available to cover for his teammates and make important interventions. He also shows great leadership qualities for a young CB.

T = Technique I = IQ (football intelligence) P = Personality P = Power S = Speed T = Tier (potential Tier - see explainer) E = Energy
 R = Rating (Big, Medium, Small) if he moved to that Tier today

Score explanations (other than potential tiers): 0-2 = poor 3-4 = average 5-6 = good 7-8 = very good 9 = exceptional

PLAYER PROFILE

Kevin Mantilla is a 20-year-old centre-back who currently plays for Independiente Santa Fe in the Colombian top flight.

He is right-footed and can play as an RCB and LCB in a back 4 generally.

His current Transfermarket value is €1,500,000.

PLAYER HISTORY

Mantilla is a product of Santa Fe's youth setup and started playing for the main team in July 2022.

K. MANTILLA HEATMAP

All games from Liga BetPlay 2023, Liga BetPlay 2022

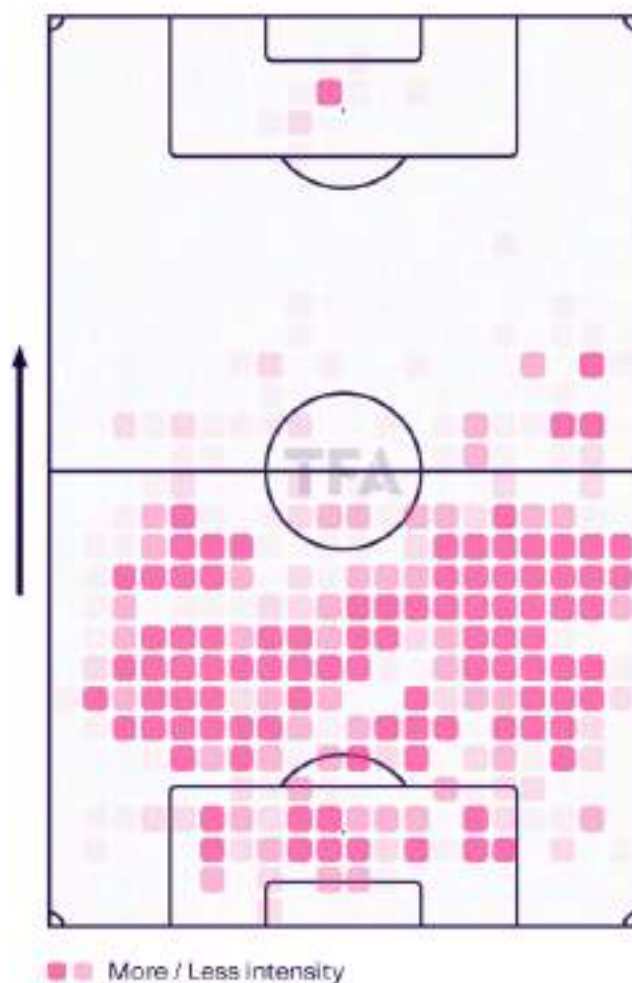

K. Mantilla | LCB | 1768 minutes played

Santa Fe | 19-years-old | Season 2022-23

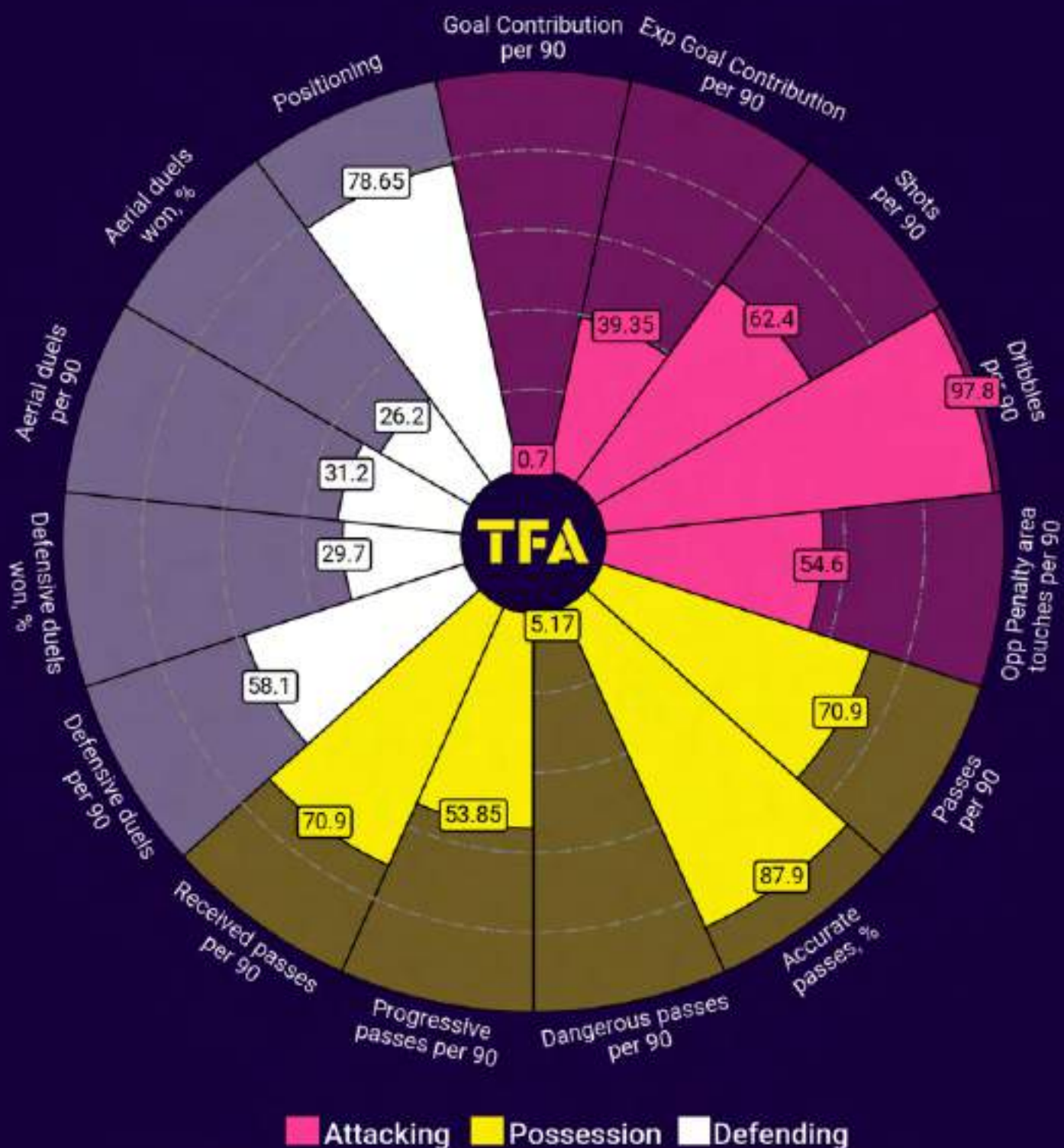

Percentile Rank vs LCBs in Colombia-Liga BetPlay-1 | Data from Season 2022-23

DEFENSIVE PHASE

Mantilla is a solid centre-back who not only positions himself well but also shows good leadership abilities, constantly speaking and gesturing to his teammates. He is aggressive and likes to step out of the line to close down his man or prevent them from turning. He covers for his teammates effectively as well. He also shows enough composure in defensive situations to not make rash decisions and try to recycle possession as much as possible instead of clearing unnecessarily.

Mantilla is a solid defender 1v1. He likes to get tight to his man, close them down quickly and prevent them from turning. He goes in strongly for tackles and looks to dispossess his man quickly. Against quicker forwards, he may not be as effective and needs to keep more distance and be patient in the duel. Mantilla is dominant in the air and is seen winning most of his aerial duels. from long balls and crosses in both boxes.

K. MANTILLA DEFENSIVE TERRITORY

All games from Liga BetPlay 2023, Liga BetPlay 2022

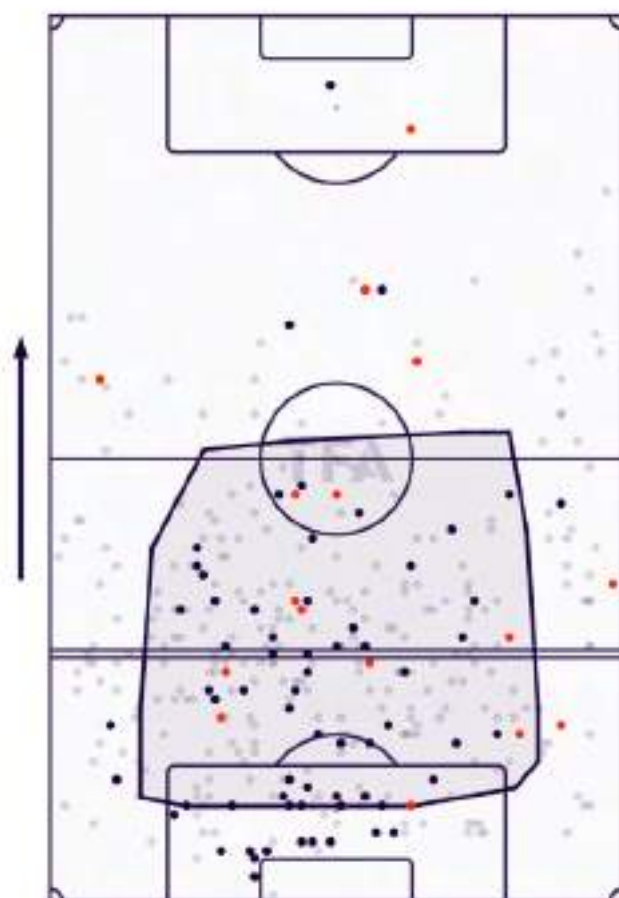

- Defensive action
- Interception
- Foul

ATTACKING PHASE

Mantilla is very composed on the ball and comfortable playing out from the back. He is seen playing numerous short passes out wide to his full-backs or into his central midfielders to progress the play. He can play incisive passes through lines but needs to do so more often. He also shows good range with his long diagonals and direct balls into his forwards but it rarely allows his team to retain possession.

Mantilla is confident on the ball and understands when to dribble and when to play safe. He has the composure to draw a challenge and cleverly evade the tackle, showing good strength and pace to run with the ball. He is often seen playing a short pass and dropping deep to create passing angles and receive again.

Although Mantilla was not seen getting on the end of too many attacking set pieces in the games watched, he is a definite threat in the opposition box because of his aerial ability. He is brave and looks to aggressively attack aerial balls which even allows him to get headers on goal.

K. MANTILLA PASS MAP

All games from Liga BetPlay 2023, Liga BetPlay 2022

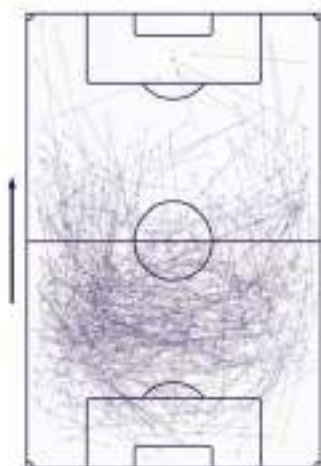

✓ Successful pass

K. MANTILLA PROGRESSIVE PASSES

All games from Liga BetPlay 2023, Liga BetPlay 2022



✓ Progressive pass
✓ Progressive pass into the penalty area

K. MANTILLA PENETRATING CARRIES

All games from Liga BetPlay 2023, Liga BetPlay 2022

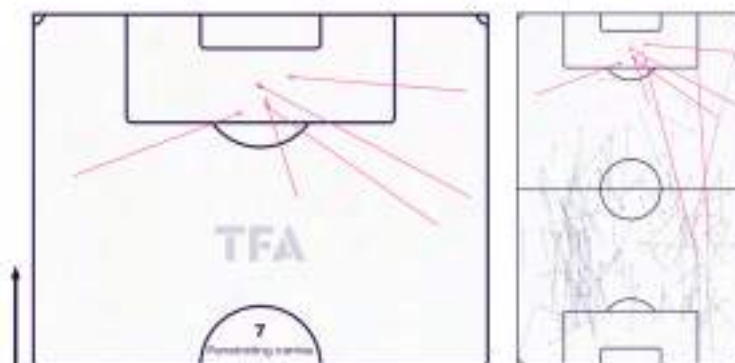

✓ Carry
✓ Carry into the penalty area

TRANSITIONS

Mantilla is decent in offensive transition. He is often seen winning back possession for his team by intercepting long balls, controlling them instead of clearing long and securing the first pass. He generally looks to release quickly after regaining possession and plays a mix of progressive and safe passes, as available to him. He is also willing to go long but not always successful.

Mantilla is very effective in defensive transition. He is often seen coming short with his man, getting tight to their back and preventing them from turning or looking to nick the ball ahead of them. He is very quick to get into wider positions to intercept through balls down the channels and does well in duels out wide.

K. MANTILLA BALL PROGRESSION

All games from Liga BetPlay 2023, Liga BetPlay 2022



PHYSICAL PROFILE

Mantilla is 185cm tall and has an athletic build. He is physically strong and has a good leap which makes him dominant aerially.

He is very brave in aerial duels and attacks the ball aggressively. Even when he does not win the header, he does not allow his man to do so because of his committed attempt.

He is also very mobile for a physical centre-back and shows decent pace over short and long distance.

SIMILAR PLAYERS USING XGOLD

xGOLD is our custom-built in-house tool that uses data to match player profiles

D. Sánchez

Tottenham
84% match

Sergio Ramos

PSG
82% match

M. Škriniar

Inter Milan
81% match



CLUB MATCHING METHODOLOGY

Our custom-built xGOLD tool has the ability to match players to clubs from a data-driven tactical fit perspective - we then take the initial shortlist and go into further scout-led filtering, considering the key points below.

A) Playing Style

Assessing teams by their playing style and finding a suitable match for Mantilla: We are looking for teams that look to keep possession of the ball and attempt a high number of progressive passes.

B) Leagues

We are looking at options for teams in France, Germany, Belgium and the Netherlands.

C) Statistics

Players who are statistically similar to Mantilla and whose contracts are ending and he could replace.

France - Ligue 1

Lille

- They averaged 60.5% of ball possession per 90 minutes.
- They have averaged 65.06 progressive passes per 90 minutes.
- Teamfit shows a 78% match
- Two centre-backs returning to their parent club and one is out with long-term injury.
- Will have a good chance to take a position in the starting 11.

Lyon

- They averaged 57.2% of ball possession per 90 minutes.
- They have averaged 71.7 progressive passes per 90 minutes.
- Teamfit shows an 80% match
- Will provide good depth to the current defensive unit.

Marseille

- They averaged 57.1% of ball possession per 90 minutes.
- They have averaged 66.58 progressive passes per 90 minutes.
- Teamfit shows a 77% match.
- 3 of their centre-backs will be leaving after ending their current loan spell or moving to a new club.

Germany - Bundesliga

RB Leipzig

- They averaged 57.7% of ball possession per 90 minutes.
- They have averaged 73.65 progressive passes per 90 minutes.
- Starting centre-back heavily linked with a move away from the club.
- Club has a history of promoting young talent and will have a good chance to make the starting 11.

Eintracht Frankfurt

- They averaged 51.2 % of ball possession per 90 minutes.
- They have averaged 74.28 progressive passes per 90 minutes.
- Teamfit shows an 80% match.
- 2 centre-backs leaving the club in the summer and would be a good addition to the defensive unit.

Netherlands - Eredivisie

Ajax

- They averaged 65.5% of ball possession per 90 minutes.
- They have averaged 87.49 progressive passes per 90 minutes.
- Teamfit shows an 80% match.
- Would suit their style of play and the club also has a history of promoting young talent.

Feyenoord

- They averaged 58% of ball possession per 90 minutes.
- They have averaged 73.61 progressive passes per 90 minutes.
- 2 centre-backs out of contract after completing their loan spell.
- They have two active centre-backs and will be in the market looking to add to their defensive unit.

PSV

- They averaged 57.8% of ball possession per 90 minutes.
- They have averaged 74.52 progressive passes per 90 minutes.
- Will be a good addition to the squad considering they only have one young centre-back.
- One centre-back returning to parent club are completing loan spell.

Belgium - First Division A

Antwerp

- They averaged 56% of ball possession per 90 minutes.
- They have averaged 74.32 progressive passes per 90 minutes.
- Teamfit shows a 79% match.
- Only have two active centre-backs in the squad. 1 is leaving after completing the loan spell and the other is injured.
- Will be a good young prospect for the team considering their main centre-back is above 33.

Gent

- They averaged 54.7% of ball possession per 90 minutes.
- They have averaged 77.67 progressive passes per 90 minutes.
- Teamfit shows a 77% match.
- Play a progressive type of gameplay,, building out from the back which would compliment the style of play of Mantilla.



NEWELL'S OLD BOYS



ARGENTINA

BRIAN AGUIRRE

JUNE 2023

SCOUT REPORT



Brian Nicolas Aguirre

Newell's Old Boys

Category	Description	Points
International Appearances	No data	0
Domestic Minutes	Band 3: 34%	2
Continental Minutes	No data	0
League Position	Newell's Old Boys: Argentina Superliga 0 Band 2 Qualifiers	
Continental Progression	No data	0
League Quality	Liga Profesional de Fútbol	8
Total	Exceptions Panel	10

This calculation is based on rules agreed by the FA and the Home Office for players to play in England. There will be edge cases and different interpretations. Our Governing Body Endorsement (GBE) status tool should be used as a guide to assess the likelihood of a player meeting the criteria, rather than a definitive assessment. GBE criteria are regularly reviewed by the FA and Home Office. Any changes will be incorporated into our calculations when they are announced.

NB: Our calculations don't currently take into account injury data or, for players under 21, any additional points from the youth criteria. There are variations to the GBE criteria for players to play in Scotland and details can be found on the Scottish FA website.

TFA



Brian Aguirre is a young winger who shows the ability to play as an inverted winger on the left but can be deployed as an out-and-out winger as well. He is very direct and quick on the ball as he likes to take on opponents. He has a good change of pace and also possesses the skill to beat his marker in 1v1 situations to either drive down the line or cut inside. He showcased good technique and can deliver good crosses into the box. He manages to get into promising positions but shows room for improvement with his finishing. Defensively, he provided decent support to his fullback but is more comfortable playing with lesser defensive duties. He lacks the strength to dispossess opponents but can press well higher up the pitch.

T - Technique I - IQ (football intelligence) P - Personality P - Power S - Speed T - Tier (potential Tier - see explainer) E - Energy
R - Rating (Big, Medium, Small) if he moved to that Tier today

Score explanations (other than potential tiers): 0-2 - poor 3-4 - average 5-6 - good 7-8 - very good 9 - exceptional

PLAYER PROFILE

Brian Aguirre is a 20-year-old attacker who plays for Newell's Old Boys in the Argentinian Superliga, the top tier in the country.

Aguirre is naturally right-footed and generally plays as an inverted winger on the left. He is also capable of playing on the right and uses his quick change of pace to beat defenders.

His current market value is €2,000,000.

PLAYER HISTORY

Aguirre is a product of the Newell's Old Boys youth academy and is currently playing for their first team in the Argentinian first tier.

B. AGUIRRE HEATMAP

All games from Liga Profesional de Fútbol 2023

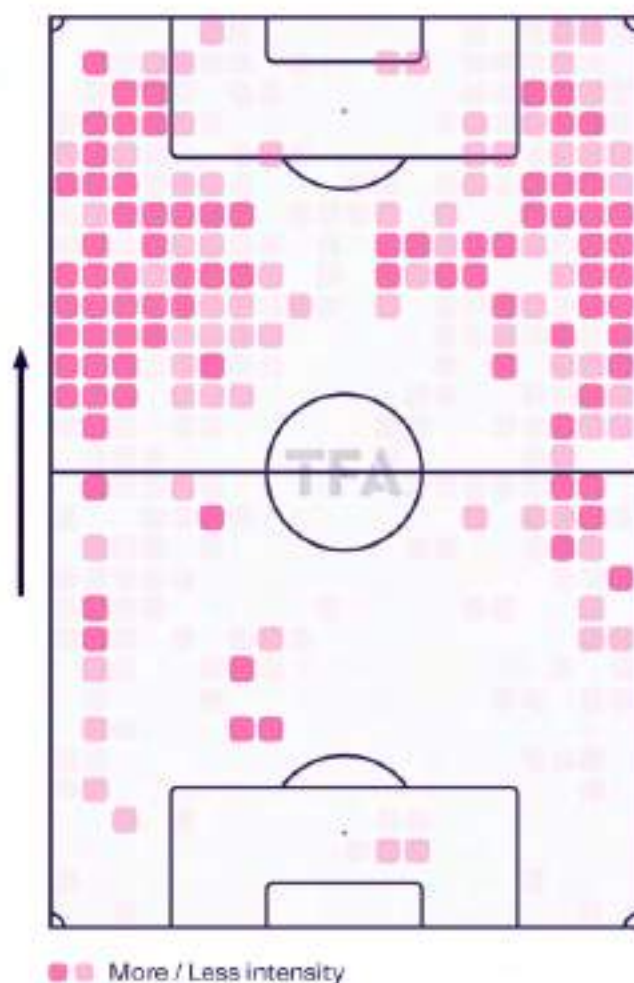

B. Aguirre | LW | 746 minutes played
Newell's Old Boys Res. | 20-years-old | Season 2022-23

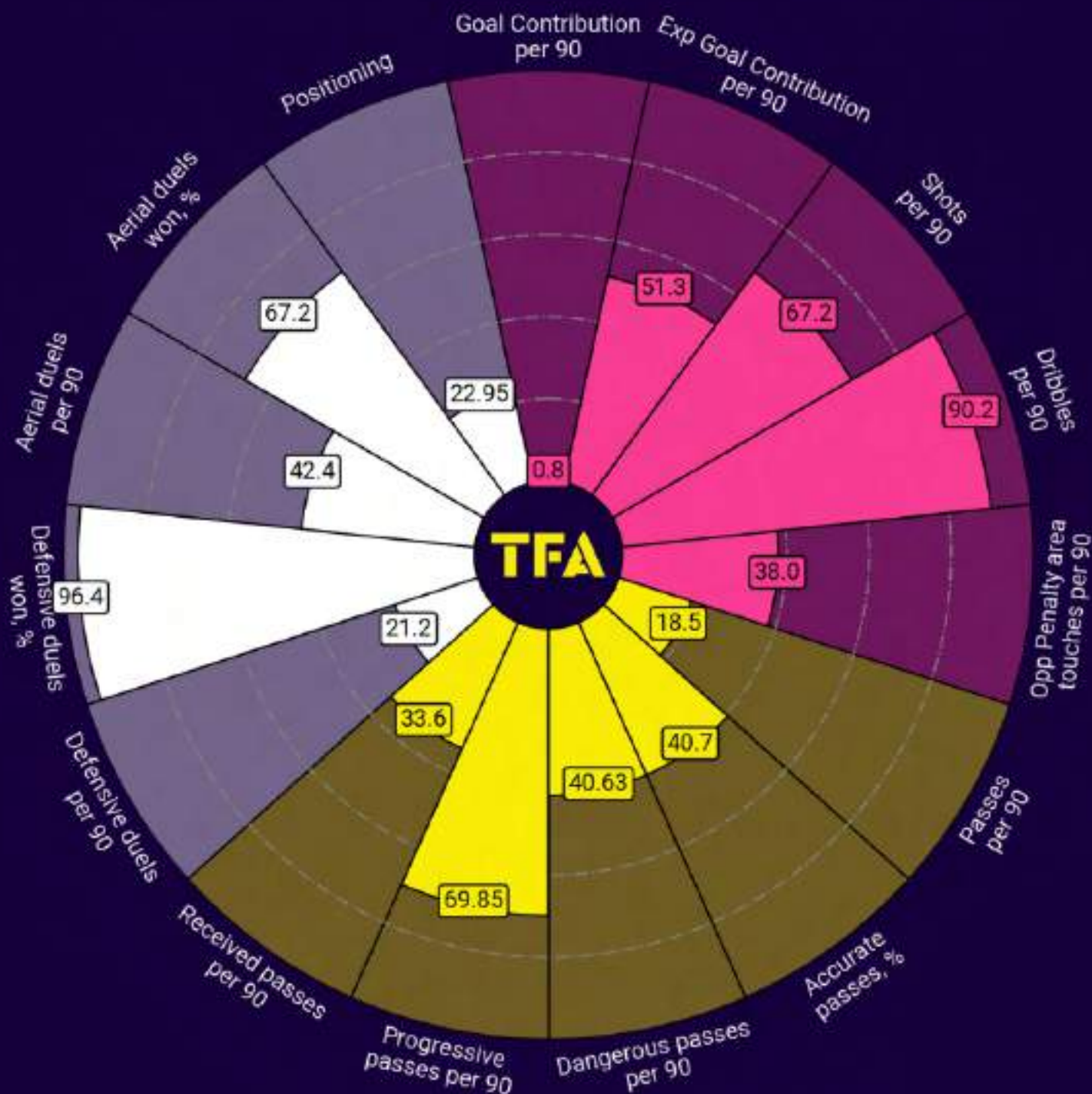

Attacking Possession Defending

Percentile Rank vs LWs in Argentina-Liga Profesional-1 | Data from Season 2022-23

DEFENSIVE PHASE

Aguirre can be quite tenacious in 1v1 situations as he tries to nick the ball away from his opponent's feet, however, he often lacked the strength to shrug off an opponent in these duels. He closes down spaces at a good pace but did not always have great timing on his tackles.

Aguirre provided decent support to his fullback in the defensive phases and was also seen dropping into his half to an extent to team up with a teammate to dispossess an opponent. He does not always drop very deep and could have shown better awareness to track the runs of his marker after a turnover.

His pressing efforts seemed to be limited to the attacking phases of the game. He presses well, especially higher up the pitch, and has shown on several occasions that he can force opponents into a poor pass.

B. AGUIRRE DEFENSIVE TERRITORY

All games from Liga Profesional de Fútbol 2023

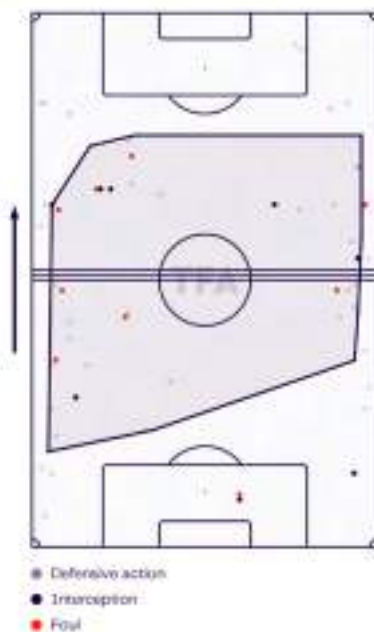

B. AGUIRRE HIGH REGAINS

All games from Liga Profesional de Fútbol 2023



ATTACKING PHASE

Aguirre makes good use of the full width of the pitch as he was often found sticking close to the byline and likes to receive in wide areas. He rarely showed any movement in behind the backline and prefers to receive the ball in deeper areas, then looking to move forward with it towards the byline or tries to cut inside to create shooting space. He is a good dribbler and has good pace and skill to beat his opponents in 1v1 duels. He is a very agile winger and also showed quick feet while dribbling the ball. However, he does not always manage to beat his man in 1v1 situations as he lacks strength and gets shrugged off the ball easily.

He demonstrated good technique from dead-ball situations and was in charge of set-pieces for his team. He gets good whip on his deliveries and also provides good flight on the ball for his teammates to attack it. He has the skill and pace to beat his marker in wider areas to deliver crosses into the box. He does manage to create shooting space for himself as he tries to cut inside onto his right foot, however, needs to improve the accuracy on his shots. He also looks to make runs towards the back post but did not always time these runs to perfection.



B. AGUIRRE PASS MAP

All games from Liga Profesional de Fútbol 2023



B. AGUIRRE PROGRESSIVE PASSES

All games from Liga Profesional de Fútbol 2023



B. AGUIRRE WINGER ACTIONS

All games from Liga Profesional de Fútbol 2023



B. AGUIRRE PENETRATING CARRIES

All games from Liga Profesional de Fútbol 2023

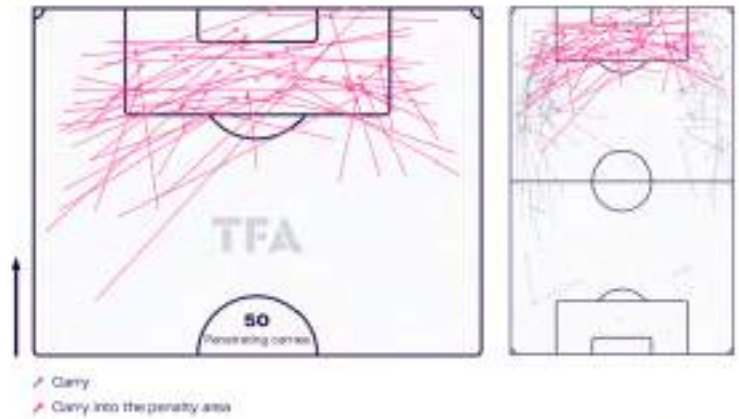

TRANSITIONS

He is a real threat on the counter because of his pace and directness. He can quickly spring counters with his pace and touches on the flanks. He likes to come deep to receive the ball and then uses his pace to get past his marker. He can dribble away from pressure and has the ability to move the ball into the final third.

Aguirre is decent in defensive transitions. He showed a decent work rate in the transition but does not always react positively to turnovers. He will drop back to an extent to support his full-back but does not drop very deep. He did not show a high desire to track back into his half.

B. AGUIRRE BALL PROGRESSION

All games from Liga Profesional de Fútbol 2023



PHYSICAL PROFILE

Aguirre stands at 178cm and has a lean athletic physique.

He has a very good pace and uses his pace to step past opponents to create overloads in the final third. He has a good pace on the ball and shows good agility to turn inside and outside to wrong foot a defender.

He is not an overly dominant defender and lacks the strength to physically impose himself on his opponent.

SIMILAR PLAYERS USING XGOLD

xGOLD is our custom-built in-house tool that uses data to match player profiles

Dani Olmo

RB Leipzig
80% match

Jack Grealish

Manchester City
80% match

Gabriel Martinelli

Arsenal
78% match



CLUB MATCHING METHODOLOGY

Our custom-built xGOLD tool has the ability to match players to clubs from a data-driven tactical fit perspective - we then take the initial shortlist and go into further scout-led filtering, considering the key points below.

A) Playing Style

Assessing teams by their playing style and finding a suitable match for Aguirre:
We are looking for teams that average a high number of 1v1 take-ons and also teams with a low PPDA value.

B) Leagues

We are looking at options for teams in Spain, Belgium and the Netherlands.

C) Statistics

Players who are statistically similar to Aguirre and whose contracts are ending and he could replace.

Spain - La Liga

Real Sociedad

- They have averaged a PPDA value of 7.44 per 90 minutes.
- They also averaged 22.52 1v1 take-ons per 90 minutes.
- Teamfit shows a match of 76%
- 84% similarity with Roberto Navarro, according to xGOLD

Valencia

- They have averaged a PPDA value of 9.89 per 90 minutes.
- They also averaged 27.29 1v1 take-ons per 90 minutes.
- Both their left-wingers are returning to their parent club in the summer after completing their loan spell.

Villarreal

- They have averaged a PPDA value of 7.44 per 90 minutes.
- They also averaged 22.52 1v1 take-ons per 90 minutes.
- Teamfit shows a match of 73%

Belgium - First Division A

Genk

- They have averaged a PPDA value of 9.13 per 90 minutes.
- They also averaged 24.56 1v1 take-ons per 90 minutes.
- They have a high-intensity high-attack style of play which would complement the strengths of Aguirre.

Standard Liege

- They have averaged a PPDA value of 10.81 per 90 minutes.
- They also averaged 32.29 1v1 take-ons per 90 minutes.
- 70% similarity with Philip Zinckernagel, according to xGOLD, who will be leaving in the summer as he returns to his parent club.

Westerlo

- They have averaged a PPDA value of 12.45 per 90 minutes.
- They also averaged 24.71 1v1 take-ons per 90 minutes.
- 4 of their attacking players are returning to their parent club after completing their loan spell, while two other players are out of contract this summer.
- They will be in the market for new additions to their attacking lineup.

Netherlands - Eredivisie

Twente

- They have averaged a PPDA value of 8.13 per 90 minutes.
- They also averaged 26.4 1v1 take-ons per 90 minutes.
- Teamfit shows a match of 72%.
- They have only one right-footed inverted winger in the squad, and could be looking for backups to add depth.

Vitesse

- They have averaged a PPDA value of 10.67 per 90 minutes.
- They also averaged 27.65 1v1 take-ons per 90 minutes.
- 4-5 attacking players leaving in the summer after completing their loan spells.
- They have a history of promoting young talent.
- 77% match with Kozlowski, who is expected to leave in the summer.

AZ Alkmaar

- They have averaged a PPDA value of 10.94 per 90 minutes.
- They also averaged 22.68 1v1 take-ons per 90 minutes.
- Teamfit shows a match of 74%.



FC TOKYO



JAPAN

NAOKI KUMATA

SCOUT REPORT

JUNE 2023



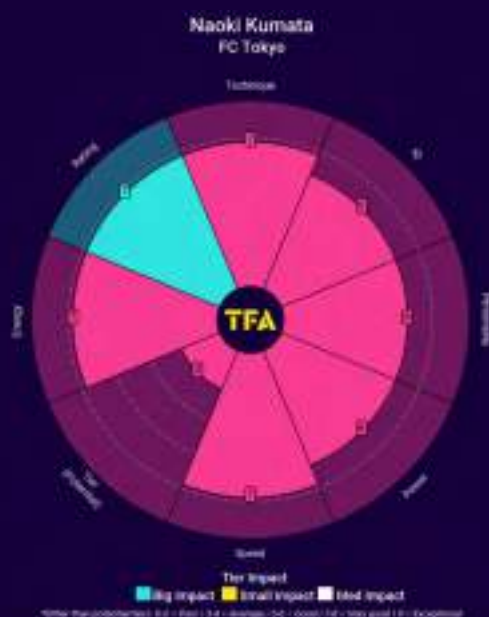

Kumata is a left-footed forward who shows good technique on the ball and does a decent job in the build-up phases. However, due to his lean physique, he can get shrugged off of possession due to intensive pressure. He has a creative vision and shows the potential to even create chances for his teammates. Has good shooting instincts and is clinical with his shots from close range as well as from range. In transitions, his job is more to link up the play and drive the team forward. Defensively, he shows good effort and has a decent work rate.

T - Technique I - IQ (football intelligence) P - Personality P - Power S - Speed T - Tier (potential Tier - see explainer) E - Energy
R - Rating (Big, Medium, Small) if he moved to that Tier today

Score explanations (other than potential tiers): 0-2 = poor 3-4 = average 5-6 = good 7-8 = very good 9 = exceptional

PLAYER PROFILE

Naoki Kumata is an 18-year-old forward who plays as a striker for FC Tokyo in the J1 League, the top tier in Japan.

He is predominantly left-footed. He is a striker who likes to drop deep to link up play and also showed good instincts inside the penalty area.

Kumata has a current market value of €50,000.

PLAYER HISTORY

Kumata is a product of the FC Tokyo academy and was promoted to the senior team in January 2023. Kumata has represented the national team at the U20 level and has recently played the U20 World cup.

N. KUMATA HEATMAP

All games from AFC U20 Asian Cup 2023 Uzbekistan, J-League Cup 2023

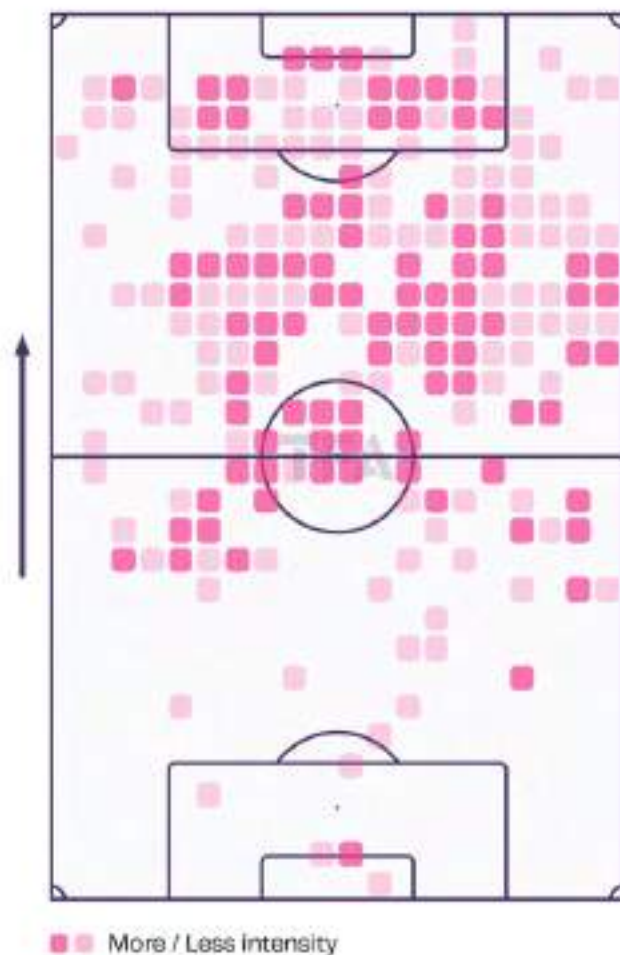

DEFENSIVE PHASE

Kumata did not look to intensively press high up the pitch for long durations and chose to reserve his energy. He did press, but on selective occasions and was more active when the ball was passed into the midfield. Also, came down to defend corners with his team and did a reasonably good job.

Most of his defensive contribution is higher up the pitch or in the midfield, especially during transitions.

N. KUMATA DEFENSIVE TERRITORY

All games from AFC U20 Asian Cup 2023 Uzbekistan, J-League Cup 2023



N. KUMATA HIGH REGAINS

All games from AFC U20 Asian Cup 2023 Uzbekistan, J-League Cup 2023

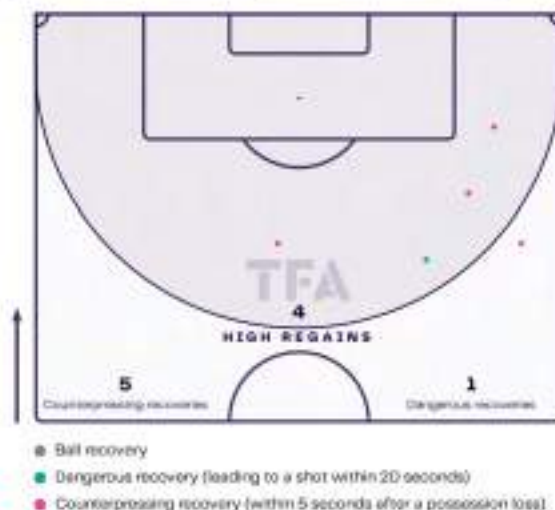

ATTACKING PHASE

Kumata shows a decent first touch and has the ability to receive on either side of his body. Was also able to lay off balls with his first touch to a close teammate. He did not look to turn with the ball much but showed a decent technique to receive on the half turns on occasions. However, did struggle to retain the ball when put under pressure with his back to goal and was dispossessed like this on a few occasions. Shows decent dribbling prowess and was able to manoeuvre the ball in tight spaces. He did lose possession in 1v1 situations and was generally better when he created space to shoot. His movements were versatile and difficult to be predicted.

Shows good balance in his creative and finishing abilities. There were moments when he played some good through balls and also put in some crosses from the attacking midfield areas. He also shows good box presence and can create space for himself. He has good shooting instincts and scored a goal from a distance, and also showed the awareness required in the box from close range. Shows good aerial prowess as well with well-timed jumps.

N. KUMATA SHOTS
All games from AFC U20 Asian Cup 2023 Uzbekistan, J-League Cup 2023



N. KUMATA SHOT ASSISTS
All games from AFC U20 Asian Cup 2023 Uzbekistan, J-League Cup 2023



N. KUMATA PASS MAP

All games from AFC U20 Asian Cup 2023 Uzbekistan, J-League Cup 2023



✓ Successful pass

N. KUMATA PROGRESSIVE PASSES

All games from AFC U20 Asian Cup 2023 Uzbekistan, J-League Cup 2023



✓ Progressive pass
✓ Progressive pass into the penalty area

N. KUMATA PENETRATING CARRIES

All games from AFC U20 Asian Cup 2023 Uzbekistan, J-League Cup 2023

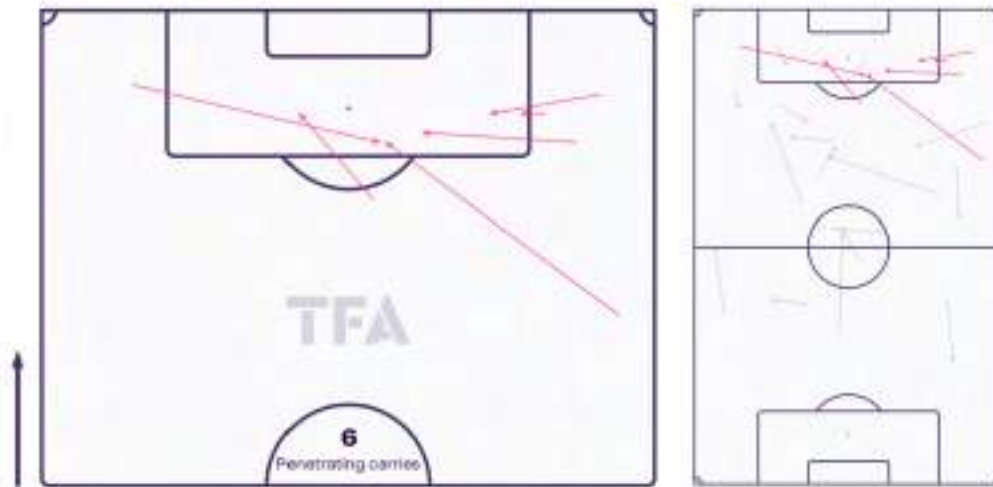

✓ Carry
✓ Carry into the penalty area

TRANSITIONS

Kumata generally comes short to link up around the midfield third during attacking transitions. Did carry the ball upfield from these areas and also exchanged passes and ran off the ball to receive the ball back in more advanced areas. Was not able to find the best final pass on the run, but his shots were quite accurate when he was able to use his stronger left foot.

Shows good aggression during defensive transitions and looks to recover the ball in a high area. Shows a good work rate and tracks back if the opponent on the ball is close to him. Was also seen dropping into his half to defend when his team was winning.

N. KUMATA BALL PROGRESSION

All games from AFC U20 Asian Cup 2023-Uzbekistan, J-League Cup 2023, J-League 2023, J-League Cup 2022



PHYSICAL PROFILE

Naoki Kumata stands at 181cm in height and has a lean but skinny build.

He showed decent strength to hold off pressure against his opponents but still has room for improvement. He will have to improve his physique in order to play at a higher tier in the future. He does have a decent pace but is not too quick off the ground.

He shows decent levels of intensity in the game and was seen closing down spaces in the final third.

CLUB MATCHING METHODOLOGY

Our custom-built xGOLD tool has the ability to match players to clubs from a data-driven tactical fit perspective - we then take the initial shortlist and go into further scout-led filtering, considering the key points below.

A) Playing Style

Assessing teams by their playing style and finding a suitable match for Kumata: Teams who average a higher number of touches in the opposition penalty area and who have high shots on goal per 90 minutes.

B) Leagues

We are looking at options for teams in Scotland, Belgium and the Netherlands.

C) Statistics

Players who are statistically similar to Kumata and whose contracts are ending and he could replace.

Scotland - Premiership

Celtic

- They have averaged 32.76 touches in the opposition penalty area per 90 minutes.
- They have averaged 15.81 shots on goal per 90 minutes.
- Their style of play suits a striker like Kumata who relies on his instincts to score goal.
- His gameplay is similar to Kyogo Furuhashi.

Rangers

- They have averaged 28.68 touches in the opposition penalty area per 90 minutes.
- They have averaged 16.33 shots on goal per 90 minutes.
- Alfredo Morelos is out of contract in the summer, they only have two strikers in the current squad.

Hearts

- They have averaged 16.86 touches in the opposition penalty area per 90 minutes.
- They have averaged 10.42 shots on goal per 90 minutes.
- They have the highest attacking output in the Premiership after Celtic and Rangers. Kumata could fit into the system well as they play with a front two.

Belgium - First Division A

Club Brugge

- They have averaged 20.5 touches in the opposition penalty area per 90 minutes.
- They have averaged 13.06 shots on goal per 90 minutes.
- All three of their strikers are currently injured with an unknown return date (According to Transfermarkt)

Gent

- They have averaged 19.21 touches in the opposition penalty area per 90 minutes.
- They have averaged 12.26 shots on goal per 90 minutes.
- They usually play with a front two, which suits the style of play for Kumata.

Genk

- They have averaged 18.3 touches in the opposition penalty area per 90 minutes.
- They have averaged 11.47 shots on goal per 90 minutes.
- They currently have only one centre-forward in the squad.
- Kumata could be a good option as a backup initially.

Netherlands - Eredivisie

PSV

- They have averaged 25.5 touches in the opposition penalty area per 90 minutes.
- They have averaged 15.54 shots on goal per 90 minutes.
- Couple of players leaving the club in the summer after completing their loan spells.
- Their playing style would suit the strengths of Kumata.

Twente

- They have averaged 24.38 touches in the opposition penalty area per 90 minutes.
- They have averaged 15.27 shots on goal per 90 minutes.
- Manfred Ugalde is leaving in the summer and their other striker, Wolfswinkel is 34 years old.
- Kumata will have a chance to get good game time.



FEYENOORD U21



SLOVAKIA

LEO SAUER

JUNE 2023

SCOUT REPORT

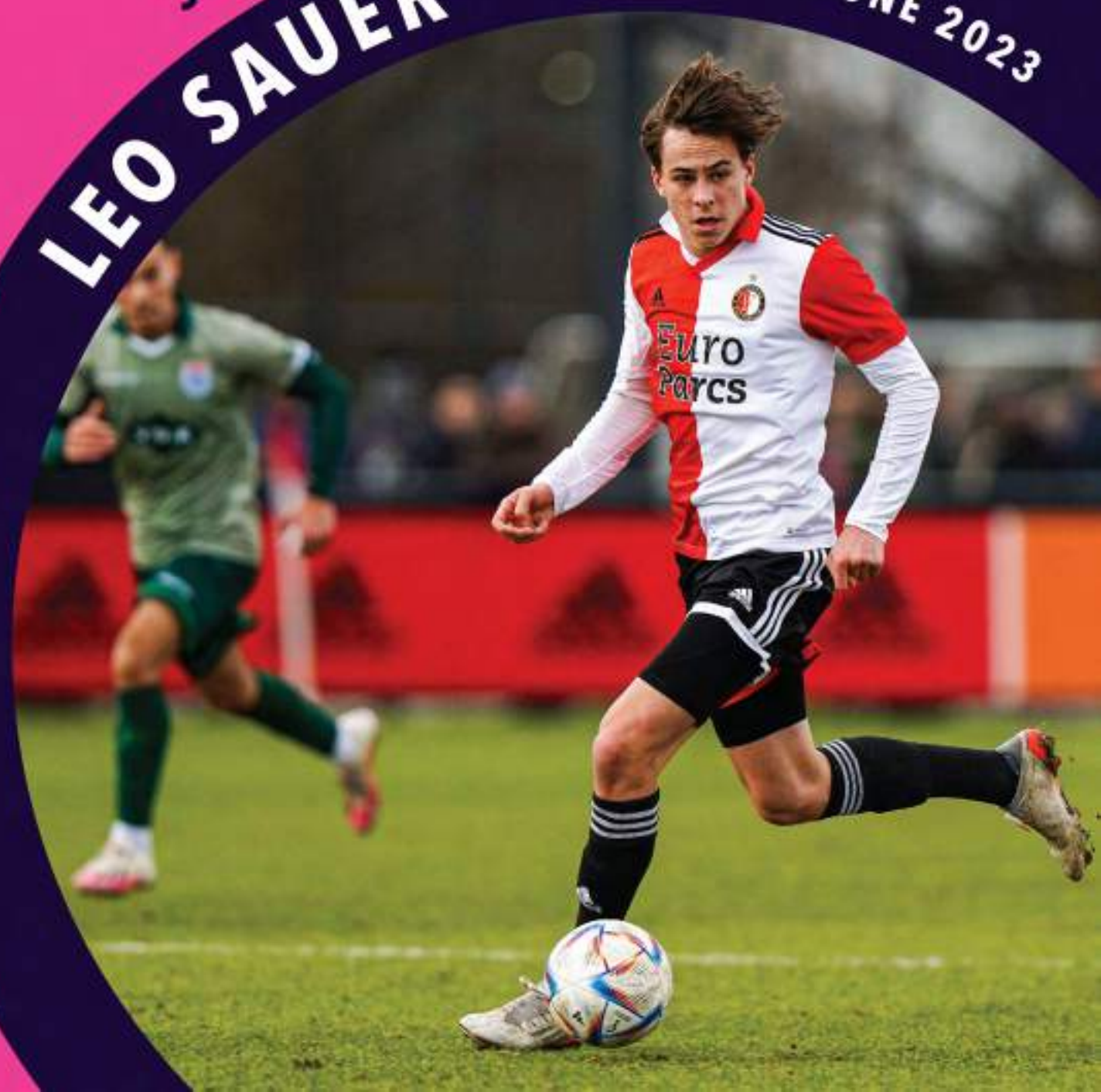

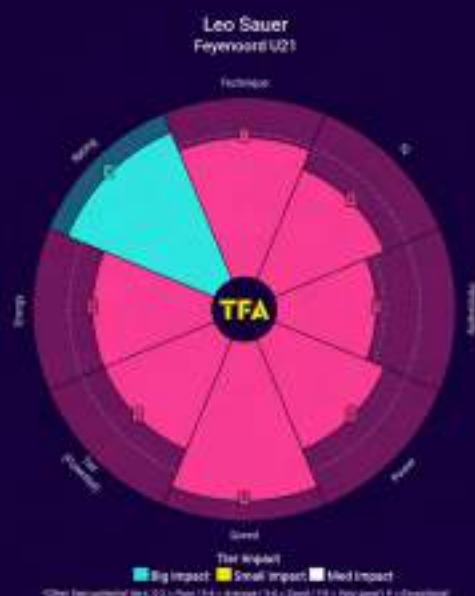

Leo Sauer is a talented 17 year old winger with great potential. He is very quick and direct. He is at his most dangerous when driving down the left flank, getting to the byline and crossing the ball into dangerous areas, causing consistent problems for defenses. He is very fast and difficult to stop once he is in his stride. He is also clever with his passing in the final third although he is still improving. He can work on his finishing and decision making as a young forward but is set for a bright future nonetheless. Defensively he does not have the greatest involvement and can improve his pressing.

T - Technique I - IQ (football intelligence) P - Personality P - Power S - Speed T - Tier (potential Tier - see explainer) E - Energy
R - Rating (Big, Medium, Small) if he moved to that Tier today

Score explanations (other than potential tiers): 0-2 - poor 3-4 - average 5-6 - good 7-8 - very good 9 - exceptional

PLAYER PROFILE

Leo Sauer is a 17 year old winger who plays for Feyenoord U21s in the Dutch U21s Division 1, youth league.

He is predominantly right-footed and can play as a left or right winger.

His current market value is €75,000.

PLAYER HISTORY

Sauer was a part of Slovan Bratislava youth before joining MSK Zilina youth. He joined Feyenoord U21 on loan from Zilina in June 2022 and will make his move permanent in July 2023. He is also a part of the Slovakia u20 side at the ongoing u20 World Cup.

L. SAUER HEATMAP

All games from UEFA U19 Championship Qualification 2023 Malta, Torneio Internacional Algarve U17 2022, U19 National Team Friendlies 2022

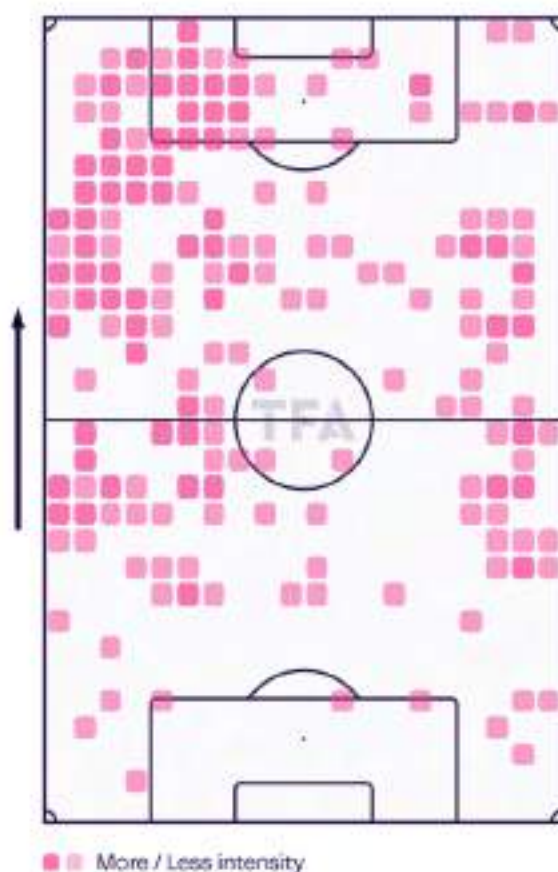

DEFENSIVE PHASE

Sauer does not have the greatest defensive contribution inside his own half but is willing to drop back and help out his fullbacks. He generally stays ahead of the midfield line when defending deep, and looks to close down the opposition full back or defensive midfielder. He is seen dropping back to double up with his fullbacks but is not seen making too many meaningful defensive interventions. When pressing higher up the pitch, he does so as a unit and is rarely seen pressing solely and causing problems.

L. SAUER DEFENSIVE TERRITORY

All games from UEFA U19 Championship Qualification 2023 Malta, Torneo Internacional Algarve U17 2022, U19 National Team Friendlies 2022

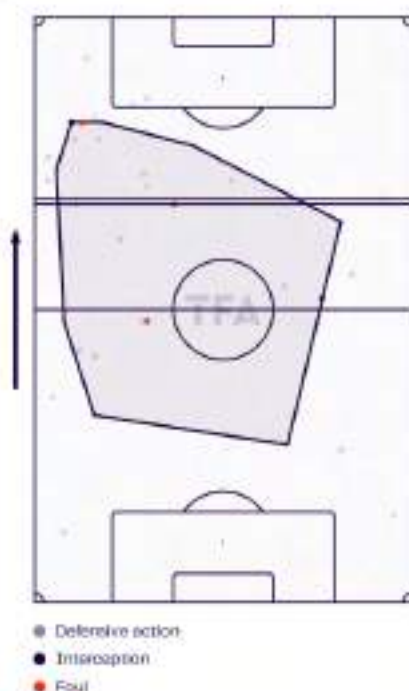

L. SAUER HIGH REGAINS

All games from UEFA U19 Championship Qualification 2023 Malta, Torneo Internacional Algarve U17 2022, U19 National Team Friendlies 2022



ATTACKING PHASE

Sauer is a versatile winger who can play on either flank. He does not stick to the touchline and likes to come in field and occupy the half spaces. He likes to have the ball played into his feet but is willing to make runs down the outside, especially when spaces open up on the counter.

He is an excellent dribbler who relies on his blistering pace to beat his man 1v1. He also has the trickery to beat players in tight areas but generally relies on his turn of pace to beat defenders 1v1. He is at his most dangerous when driving down the left flank, going past the outside of defenders and putting in dangerous crosses from the byline. He can ride challenges when running at pace or even draw fouls as he is almost unstoppable when running with the ball. He can put crosses across the 6 yard box with his left foot or cut it back towards the edge of the area, creating numerous chances in the process.

He has the creativity to play clever short passes in the final third. He is often seen playing quick short passes while driving in field as well as incisive through balls to find his teammates in openings. Even though he does not always find his teammate, his idea is often correct. He does get into the box often and gets on the end of chances but needs to be more instinctive with his finishing. He tends to take too long to get his shot away or not get proper direction on his shots when he is able to take them.

L. SAUER PASS MAP

All games from UEFA U21 Championship Qualification 2023 Match, Torneo Internacional
Algeria U17 2022, U21 National Team Friendlies 2022



L. SAUER PROGRESSIVE PASSES

All games from UEFA U21 Championship Qualification 2023 Match, Torneo Internacional
Algeria U17 2022, U21 National Team Friendlies 2022

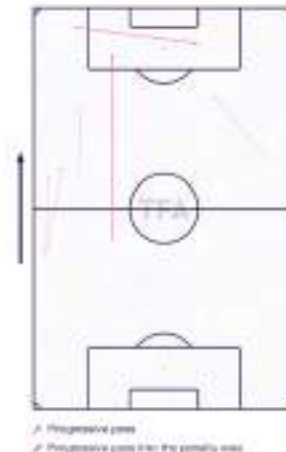

L. SAUER SHOT ASSISTS

All games from UEFA U19 Championship Qualification 2023 Malta, Torneo Internacional Algarve U17 2022, U19 National Team Friendlies 2022

L. SAUER PENETRATING CARRIES

All games from UEFA U19 Championship Qualification 2023 Malta, Torneo Internacional Algarve U17 2022, U19 National Team Friendlies 2022

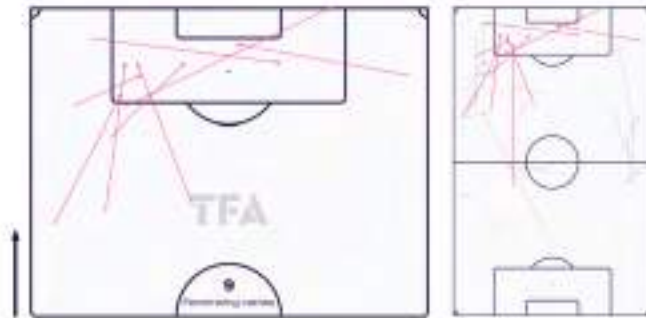

- Carry
- Carry into the penalty area



- Shot assist / Assist

L. SAUER SHOTS

All games from UEFA U19 Championship Qualification 2023 Malta, Torneo Internacional Algarve U17 2022, U19 National Team Friendlies 2022



- Goal
- Shot on target
- Missed / Blocked shot
- xG value
- Heatmap based on the game's context

L. SAUER WINGER ACTIONS

All games from UEFA U19 Championship Qualification 2023 Malta, U19 National Team Friendlies 2022, Torneo Internacional Algarve U17 2022



- More / Less intensity
- Successful / Unsuccessful dribbles

L. SAUER CROSSING ZONES

All games from UEFA U19 Championship Qualification 2023 Malta, Torneo Internacional Algarve U17 2022, U19 National Team Friendlies 2022

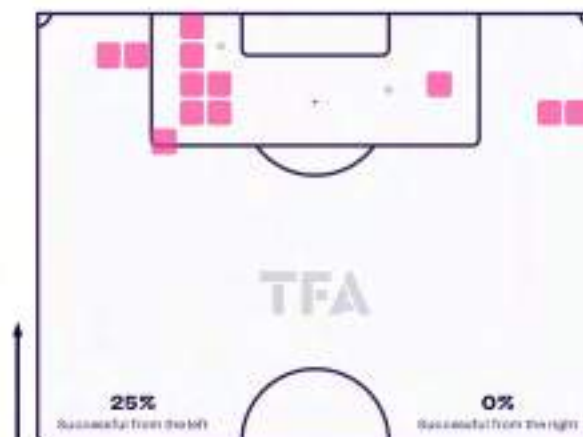

- Frequent dispatching zones
- Successful crossing destinations

TRANSITIONS

Sauer is very dangerous on the counter. When given space around to take on defenders 1v1, he is often seen accelerating past them and leaving them for dead, especially when running down the left flank. He also has the willingness to make runs down the sides of the defense to provide options. He carries the ball at pace but shows good retention to keep a hold and release accurately more often than not.

Sauer shows decent reactions in defensive transition. He is willing to counter press and make tackles close to him but does not aggressively close down. He can also show more intensity when tracking back.

L. SAUER BALL PROGRESSION

All games from UEFA U19 Championship Qualification 2023, Malta, Torneo Internacional Algarve U17 2022, U19 National Team Friendlies 2022



PHYSICAL PROFILE

Sauer stands at 184cm and has an athletic lean physique. He is not the most physically imposing but his relatively large frame allows him to ride challenges and he does not go down easily under pressure.

He shows great pace and explosiveness which makes him very difficult to cope with in 1v1 duels. Once he gets into his stride with the ball, he is very difficult to stop. He plays with decent intensity throughout the 90.

CLUB MATCHING METHODOLOGY

Having looked at Sauer's playing profile and metrics we have chosen the shortlisted clubs based on the following;

A) Playing Style

Assessing teams by their playing style and finding a suitable match for Sauer: Teams who average high crosses and dribbles per 90, or need to improve on these aspects.

B) Leagues

We are looking at options at teams in Netherlands Eerste Divisie 2, Turkey 1.Lig and Belgium-First Division B-2

C) Statistics

Players who are statistically similar to Sauer and whose contracts are ending and he could replace.

Netherlands Eerste Divisie

Ajax II

- They average 35.2 dribbles per 90, highest in the league.
- Will be losing 2 wingers in Sontje Hansen and Amourricho van Axel Dongen in the summer

PSV II

- They average 31.2 dribbles per 90, third highest in the league.
- Will be losing 2 wingers in Dante Sealy and Ilyas Bougafer in the summer.

FC Eindhoven

- They average 28.6 dribbles per 90.
- Will be losing 3 wingers in Charles Andreas-Brym, Moussa Sanoh and Tibo Persyn, in the summer

Turkey 1.Lig

Rizespor

- They average 27.1 dribbles per 90.
- Will be losing 2 wingers in the summer and have only 1 winger under the age of 23.

Eyupspor

- They average 26.3 dribbles per 90.
- Will be losing 1 winger in the summer, leaving them with no wingers under 23.

Goztepe

- They average 20.03 dribbles per 90, lower than league average.
- Will be losing 3 forwards in the summer as they return to their parent clubs after their loan spell.

Belgium First Division B

Jong Genk

- They average 30.73 dribbles per 90.
- Currently only have 2 registered out and out wingers in their regular squad.

Anderlecht SC

- They average 30.63 dribbles per 90.
- Will be losing 1 Simon Michiez, their most regular winger, in the summer.

Beerschot VA

- They average 29.9 dribbles per 90.
- Currently only have 2 registered out and out wingers in their squad, Nokkvi Thorisson and Thibaud Verlinden.



MSK ZILINA



SLOVAKIA

TIMOTEJ JAMBOR

JUNE 2023

SCOUT REPORT



Timotej Jambor

MSK Zilina

Category	Description	Points
International Appearances	No data	0
Domestic Minutes	Band 6: 47%	0
Continental Minutes	No data	0
League Position	Žilina: Slovakia Super Liga - #9	0
Continental Progression	No data	0
League Quality	Super Liga	2
Total	Ineligible	2

This calculation is based on rules agreed by the FA and the Home Office for players to play in England. There will be edge cases and different interpretations. Our Governing Body Endorsement (GBE) status tool should be used as a guide to assess the likelihood of a player meeting the criteria, rather than a definitive assessment. GBE criteria are regularly reviewed by the FA and Home Office. Any changes will be incorporated into our calculations when they are announced.

NB: Our calculations don't currently take into account injury data or, for players under 21, any additional points from the youth criteria. There are variations to the GBE criteria for players to play in Scotland and details can be found on the Scottish FA website.

TFA

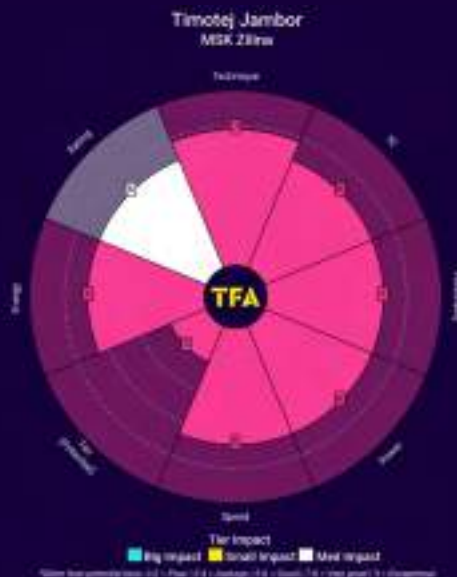

Timotej Jambor is a young striker with good technical ability and decent physicality, especially for a 20 year old. He likes to come short and link up play but has great presence in the opposition box as well. He has great shooting ability and can cause problems with his quick shots from distance and close range. He is also an aerial threat because of his height and heading technique. He can work on the execution of his final passes and runs in behind but has the years to do so. He is willing to work off the ball and is effective when pressing as a unit.

T - Technique I - IQ (football intelligence) P - Personality P - Power S - Speed T - Tier (potential Tier - see explainer) E - Energy
R - Rating (Big, Medium, Small) if he moved to that Tier today

Score explanations (other than potential tiers): 0-2 = poor 3-4 = average 5-6 = good 7-8 = very good 9 = exceptional

PLAYER PROFILE

Timotej Jambor is a 20 year old Slovakian center forward who plays for MSK Zilina in the Slovakian top flight.

He is right footed and plays as a center forward generally in a front 3 but can also play as a second striker.

He has a current market value of 275,000 euros.

PLAYER HISTORY

Jambor started with Presov youth before joining Zilina youth and moving up the ranks. He joined the Zilina first team in July 2020. He is also a part of the Slovakia u20 squad at the FIFA U20 World Cup.

T. JAMBOR HEATMAP

All games from Super Liga 2022/2023

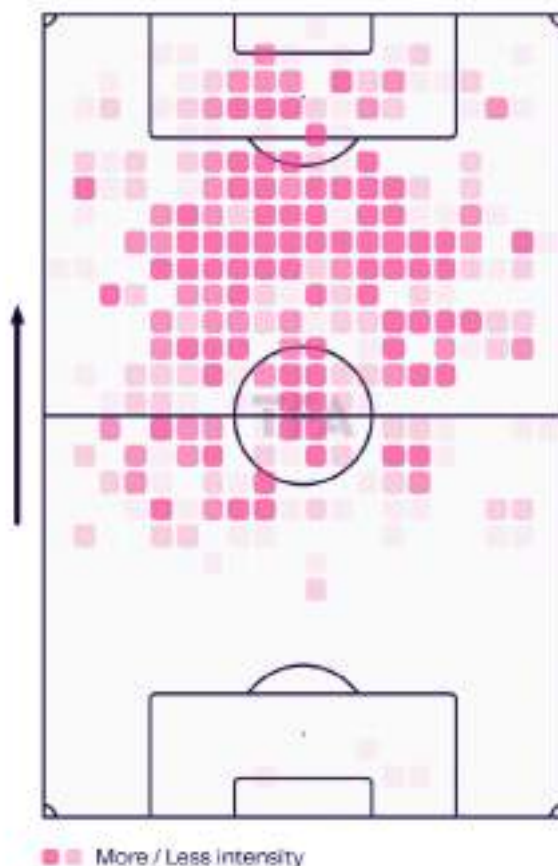

T. Jambor | CF | 1877 minutes played
 Žilina | 20-years-old | Season 2022-23

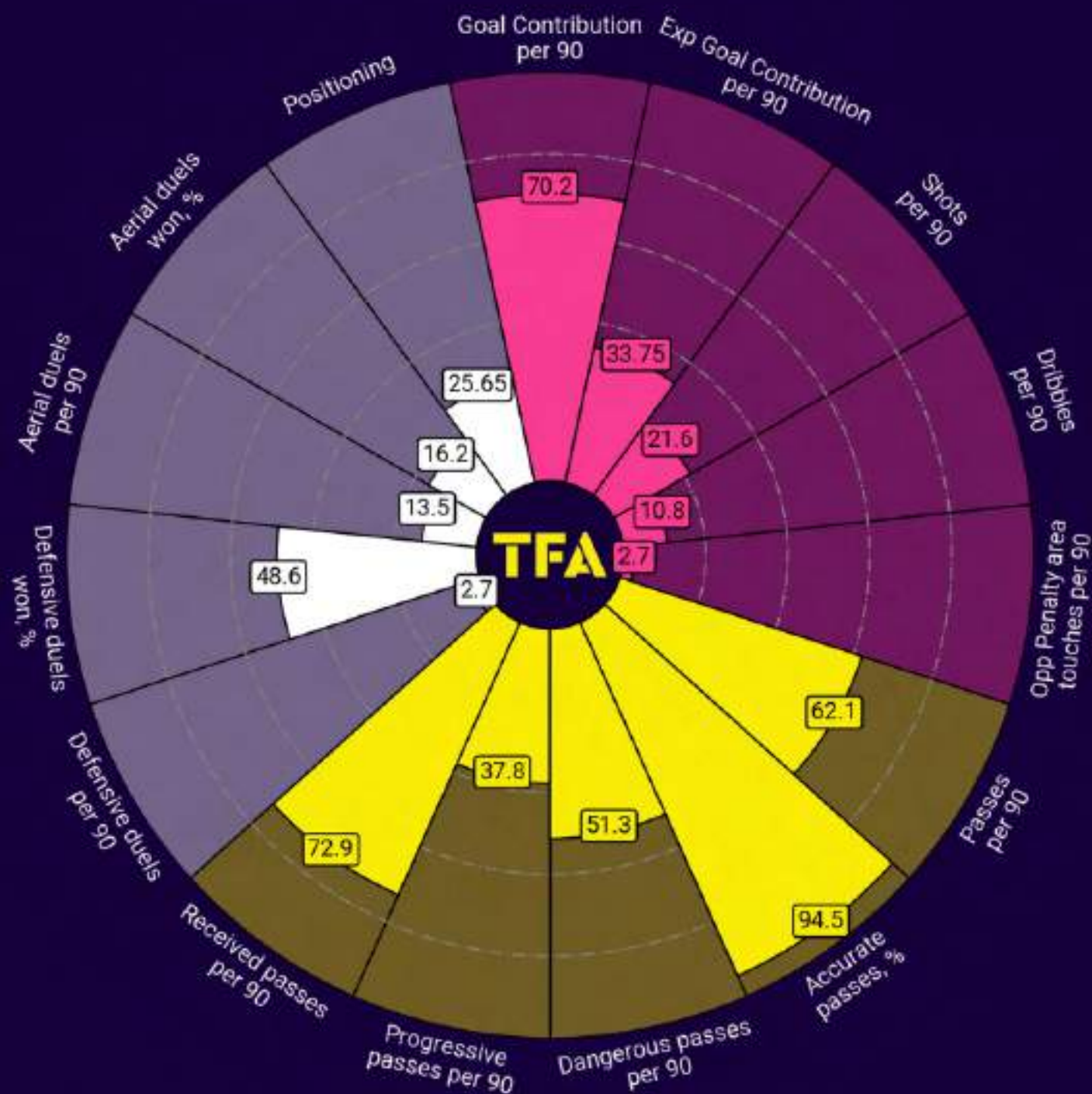

■ Attacking ■ Possession ■ Defending

Percentile Rank vs CFs in Slovakia-Superliga-1 | Data from Season 2022-23

DEFENSIVE PHASE

Jambor shows good work rate off the ball. He has the energy and pace to press and can cause problems especially when pressing as a unit. He is quick to close down himself as well as cut out passing lanes for the opposition defenders. Because of his aerial prowess, he is also seen helping out from defensive set pieces.

T. JAMBOR DEFENSIVE TERRITORY

All games from Super Liga 2022/2023

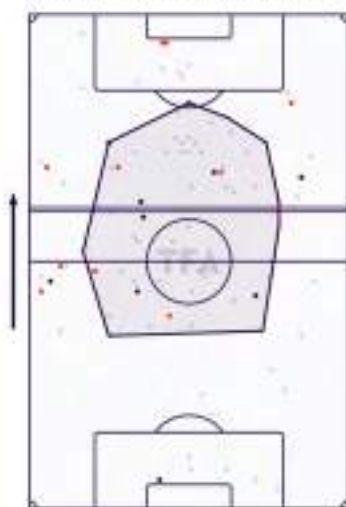

- Defensive action
- Interception
- Foul

T. JAMBOR HIGH REGAINS

All games from Super Liga 2022/2023



- Ball recovery
- Dangerous recovery (leading to a shot within 20 seconds)
- Counterpressing recovery (within 5 seconds after a possession loss)

ATTACKING PHASE

Jambor is a conventional center forward who can also play as a second striker. He likes to drop deep into the #10 position and link up the play with his teammates. He also has the pace to make runs in behind and generally does so in between CBs or down the sides of them. He does not look to go out wide often and likes to stay in central areas.

He has good receiving technique, looking to turn with the ball and give himself space to shoot when receiving in the final third. He also takes a secure first touch when receiving under pressure between lines and tries to link up the play. he shows good technique to receive and find a teammate, generally out wide and is effective with his playmaking skills. He has the ability to spot gaps and runs in behind but needs to work on the execution of his through balls. He has decent pace but lacks the trickery and explosiveness to dominate 1v1.

Jambor is an excellent finisher. He has great shooting technique and gets a lot of power behind his shots from distance. He is not afraid to take quick shots from range and can work the keeper consistently with his long range efforts. He also does very well to find space inside the box to get on the end of crosses and loose balls. He is an aerial threat and has good technique with his headers as well as his shots from close range.

T. JAMBOR PASS MAP

All games from Super Liga 2022/2023



T. JAMBOR PROGRESSIVE PASSES

All games from Super Liga 2022/2023



T. JAMBOR PENETRATING CARRIES

All games from Super Liga 2022/2023

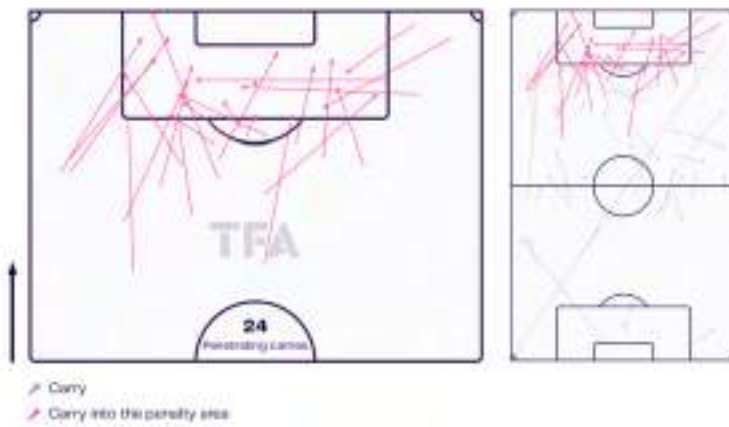

T. JAMBOR SHOT ASSISTS

All games from Super Liga 2022/2023



T. JAMBOR SHOTS

All games from Super Liga 2022/2023



TRANSITIONS

Jambor can be very dangerous on the counter because of his directness. He is quick to come short or take up positions to allow him to link up the play with limited touches. He also has the presence of mind to play a quick forward through ball or shot from distance to catch the defense out. He can look to make more runs in behind however.

Jambor is decent in defensive transition and is willing to try and win the ball higher up. He does not counter press with a consistent high intensity but is rarely ever seen static either. He does not often drop back when playing as a long CF.

T. JAMBOR BALL PROGRESSION

All games from Super Liga 2022/2023



PHYSICAL PROFILE

Jambor is 183cm tall and has an athletic powerful build. He is physically strong for his age and difficult to contain physically when faced against opponents his age and size. He has great heading technique and can hit the target or find teammates with his headers when free. He is still developing however and will improve against bigger forwards.

He has good pace over distance and decent agility despite his large frame, although he can still work on his agility. He plays the game with decent intensity.

SIMILAR PLAYERS USING XGOLD

xGOLD is our custom-built in-house tool that uses data to match player profiles

Iago Aspas

Celta Vigo

86% match

C. Nkunku

RB Leipzig

85% match

A. Griezmann

Atl. Madrid

85% match



CLUB MATCHING METHODOLOGY

Having looked at Jambor's playing profile and metrics we have chosen the shortlisted clubs based on the following;

A) Playing Style

Assessing teams by their playing style and finding a suitable match for Jambor: Teams who average high accurate passes and goals per 90, or need to improve on those aspects.

B) Leagues

We are looking at options at teams in the first divisions of Belgium, Netherlands and Turkey.

C) Statistics

Players who are statistically similar to Jambor and whose contracts are ending and he could replace..

Belgium First Division A

Westerlo

- They average 83.3% pass accuracy.
- Currently have 4 strikers out of which 2 are set to leave at the end of the season and 1 is out with a long term injury.
- Team fit: 74%

Genk

- They average 83% pass accuracy.
- Currently have 2 strikers with 1 of them returning on loan at the end of the current season.
- Team fit: 73%

Royal Antwerp

- They average 84% pass accuracy.
- Currently only have 1 recognized striker in 28 year old Vincent Janssen.
- Team fit: 75%

Netherlands Eredivisie

AZ Alkmaar

- They average 1.84 goals per 90.
- They average 85.5% pass accuracy.
- Have a large core of young players and are known for developing talent.
- Team fit: 76%

FC Twente

- They average 1.78 goals per 90.
- Currently have 2 strikers with 1 of them returning on loan at the end of the current season.
- Team fit: 74%

Heerenveen

- They average 1.2 goals per 90, one of the lowest in the top half of the league.
- Currently have 3 strikers with 2 returning on loan at the end of the current season.
- Team fit: 77%

Turkey Super Lig

Adana Demirspor

- They average 1.85 goals per 90.
- Currently have 3 strikers with 2 returning on loan at the end of the current season.
- Team fit: 75%

Fenerbahce

- They average 2.13 goals per 90.
- Currently have no strikers below the age of 23, with the youngest being 29 years old.
- Team fit: 74%

Trabzonspor

- They average 1.55 goals per 90.
- They average 85.5% pass accuracy.
- Currently have only 2 strikers both 26 years of age.
- Team fit: 78%



FAGIANO
OKAYAMA



JAPAN

KODAI SANO

JUNE 2023

SCOUT REPORT



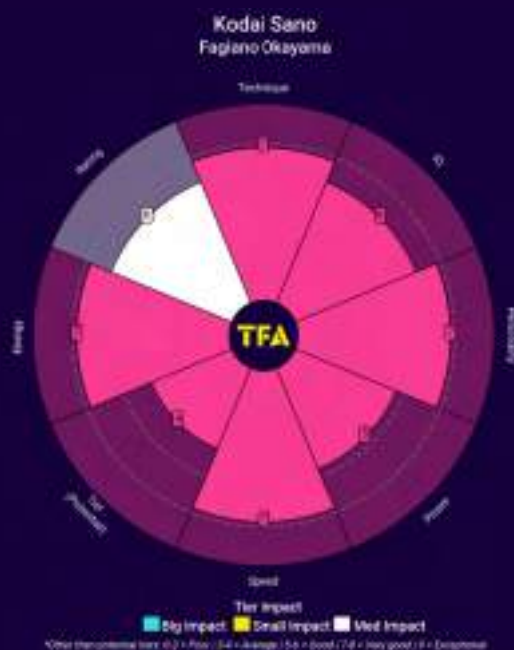

Kodai Sano is a skillful young winger who is effective as a left winger and as a box to box midfielder. He is technically sound and shows great close control to maintain possession in tight areas. He has the quick feet and acceleration to beat players on the inside and outside, creating problems with his cutbacks and in swinging crosses into the back post. He does get into the box but still needs to improve his finishing and runs into the box. He has a good work rate off the ball and is very quick to react to turnovers. He is not the strongest but makes up for it with his tenacity.

T = Technique I = IQ (football intelligence) P = Personality P = Power S = Speed T = Tier (potential Tier - see explainer) E = Energy
 R = Rating (Big, Medium, Small) if he moved to that Tier today

Score explanations (other than potential tiers): 0-2 = poor 3-4 = average 5-6 = good 7-8 = very good 9 = exceptional

PLAYER PROFILE

Kodai Sano is a 19 year old Japanese footballer who plays for Fagiano Okayama in the Japanese second division.

Sano is predominantly right-footed and is usually deployed on the left wing as an inverted winger but can also play as an 8 or box to box midfielder.

His current market value is €350,000.

PLAYER HISTORY

Sano joined Fagiano Okayama in Feb 2022 from Yonago Kita HS. He is a part of the u20 Japanese World Cup squad.

K. SANO HEATMAP

All games from J2 League 2023

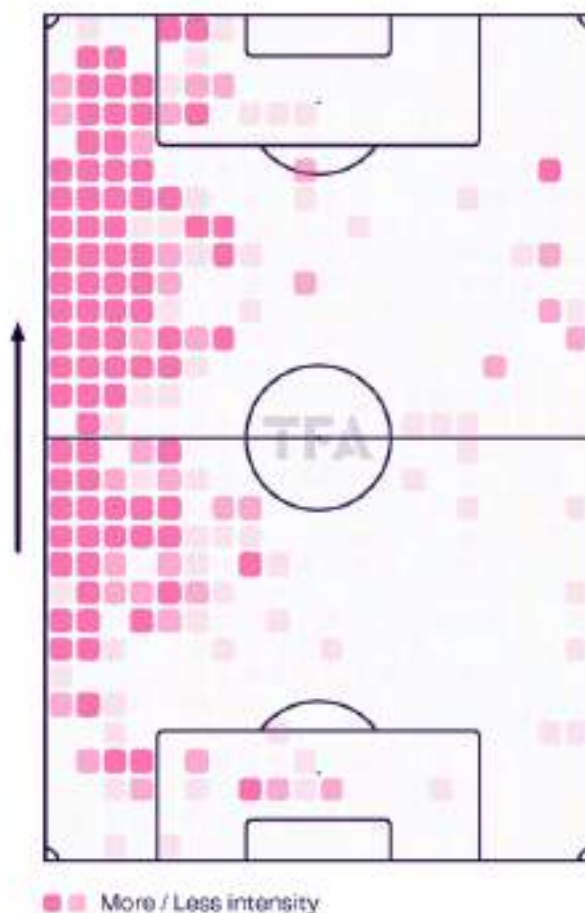

K. Sano | LW | 887 minutes played
Fagiano Okayama | 19-years-old | Season 2023

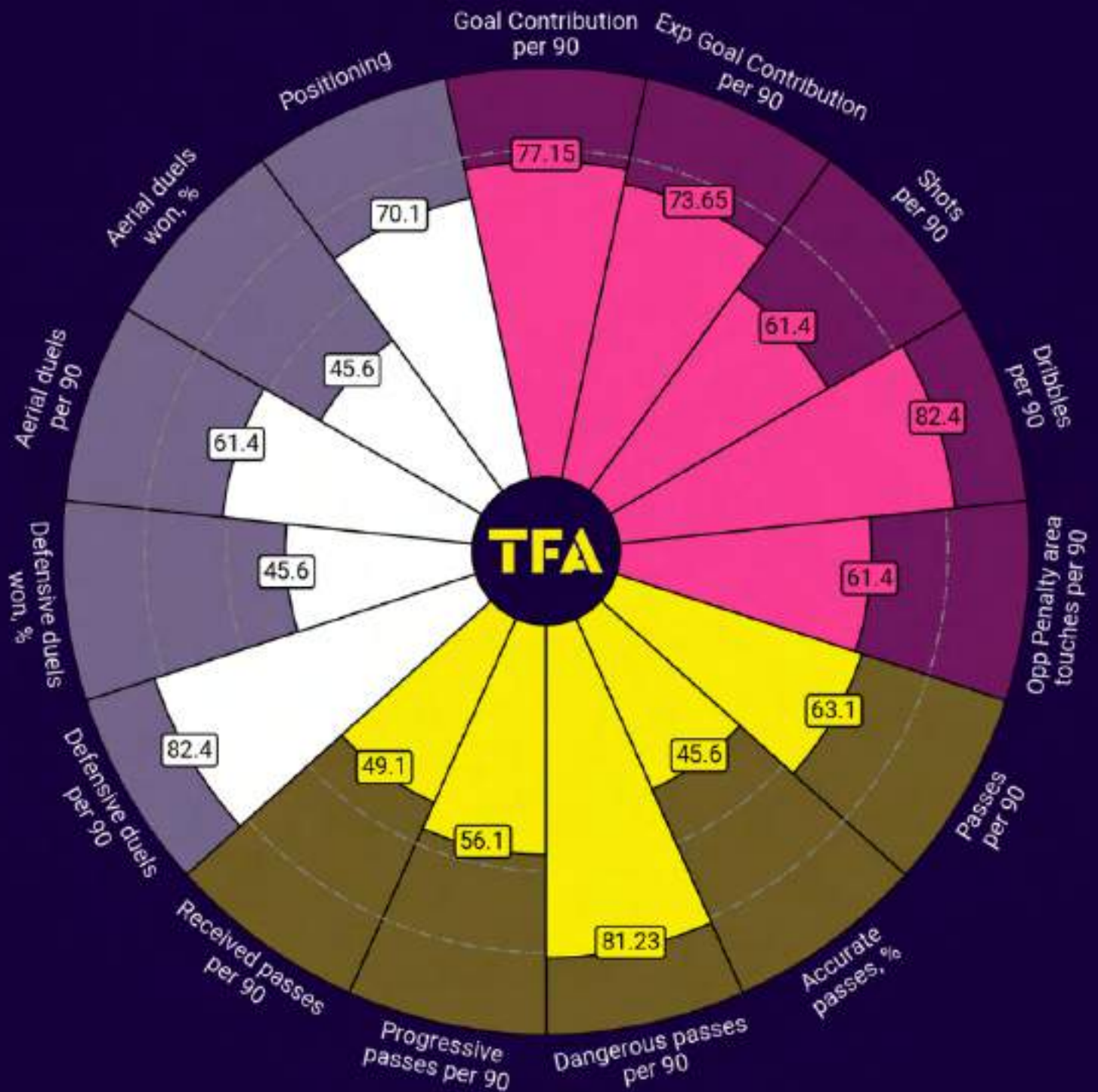

Attacking **Possession** **Defending**

Percentile Rank vs LWs in Japan-J2 League-2 | Data from Season 2023

DEFENSIVE PHASE

Sano closes down on his opponents with intensity and does well to block out their passing options. He does lack strength in his duels and was not able to win the ball from his opponents very consistently but still has the tenacity to keep fighting for possession.

He will drop back to help out his fullback and also tracks the run of the opposition fullback deep into his own half. As an 8, he did intercept several passes in the midfield to break up opposition play and was able to start quick counterattacks from these positions.

He is a tenacious tackler who does not back away from a duel, which makes up for his lack of size and physical dominance.

K. SANO DEFENSIVE TERRITORY

All games from J2 League 2023



- Defensive action
- Interception
- Foul

K. SANO HIGH REGAINS

All games from J2 League 2023



- Ball recovery
- Dangerous recovery (leading to a shot within 30 seconds)
- Counterattacking recovery (within 5 seconds after a possession loss)

ATTACKING PHASE

Sano has a strong receiving technique and showed a variety of movements to get on the ball. He will drop deep to receive the ball from his fullback or midfielders, but generally likes to keep his width along the left flank, especially when the center is compact.

He likes receiving the ball out wide and driving in field or playing quick short passes with his teammates down the flank, to create openings. He is often seen cutting in, driving in field and looking to whip crosses into the back post or play clever exchanges on the edge of the box. He also has the pace to get down the outside, drive to the byline and dig out crosses with his left foot. He has good close control and quick feet which allow him to dribble in tight spaces. He also has the acceleration to beat players with a turn of pace instead of just trickery. When playing centrally, he shows great composure and control to maintain possession in the midfield before playing clever short passes through the center to find his teammates in shooting chances.

He is willing to get in towards the back post when crosses are put into the box but can look to get on the end of more chances. He is not afraid to shoot with his strong right foot when given space but needs to do better to work the keeper.

K. SANO PASS MAP

All games from J2 League 2023



K. SANO PROGRESSIVE PASSES

All games from J2 League 2023



K. SANO PENETRATING CARRIES

All games from J2 League 2023



- Carry
- Carry into the penalty area

K. SANO SHOT ASSISTS

All games from J2 League 2023



- Shot assist / Assist

K. SANO SHOTS

All games from J2 League 2023



K. SANO WINGER ACTIONS

All games from J2 League 2023



- Runs / Late intensity
- Successful / Unsuccessful crosses
- Crosses

K. SANO CROSSING ZONES

All games from J2 League 2023



- Frequent dispatching zones
- Successful crosses destinations

TRANSITIONS

In offensive transitions, Sano showed very good reactions to get on the ball and can carry the ball into the opposition half at a good pace. When winning possession higher up the pitch, he is quick to make runs down the left, generally looking to exploit the space outside the opposition right back. He is also dangerous when picking up the ball centrally and playing clever forward passes.

Sano has excellent reactions after a turnover and work rate to constantly press his opponents. He is willing to scrap for possession in the midfield whether he is playing centrally or out wide, showing good determination and tenacity to break up play.

K. SANO BALL PROGRESSION

All games from J2 League 2023



PHYSICAL PROFILE

Sano is 176cm tall and has a lean athletic physique.

He does lack physicality in his game and is shrugged off the ball easily. However, he uses his pace and agility well to skip past challenges and also has very good mobility. He also shows excellent quick feet which allow him to keep possession in tight areas.

He is rarely seen jumping for aerial duels.

SIMILAR PLAYERS USING XGOLD

xGOLD is our custom-built in-house tool that uses data to match player profiles

Bernardo Silva

Man City
91% match

M. Tavernier

Bournemouth
90% match

R. Christie

Bournemouth
89% match



CLUB MATCHING METHODOLOGY

Having looked at Sano's playing profile and metrics we have chosen the shortlisted clubs based on the following;

A) Playing Style

Assessing teams by their playing style and finding a suitable match for Sano: Teams who average high progressive passes and dribbles per 90, or need to improve on the first aspect.

B) Leagues

We are looking at options at teams in the first divisions of Japan, Scotland and Germany Bundesliga 2

C) Statistics

Players who are statistically similar to Sano and whose contracts are ending and he could replace.

Japan J1 League

Gamba Osaka

- They average 27.3 dribbles per 90.
- They average 73.8 progressive passes per 90.
- Currently only have 1 wide player under the age of 23.
- Placed 15th in the 22-23 league table and would be looking to improve by attracting high potential youngsters.
- Team fit: 87%

Yokohama F. Marinos

- They average 22.6 dribbles per 90.
- They average 75.1 progressive passes per 90.
- Currently have no wide players under the age of 23.
- Team fit: 87%

Nagoya Grampus

- They average 22.2 dribbles per 90.
- They average 60.7 progressive passes per 90.
- Currently only have 2 wide players under the age of 23 with 1 out with a long term ankle injury.
- Team fit: 88%

Germany 2. Bundesliga

Hamburger SV

- They average 31.9 dribbles per 90.
- They average 62.5 progressive passes per 90, one of the lowest in the league.
- Currently only have 2 wide player under the age of 23 with 1 set to leave in July 2023 and another attracting attention from bigger clubs.
- Team fit: 86%

Magdeburg

- They average 28.9 dribbles per 90.
- They average 73.2 progressive passes per 90.
- Currently have no wide players under the age of 23.
- Tatsuya Ito set to leave at the end of the 22-23 season.
- Team fit: 86%

Paderborn

- They average 25.9 dribbles per 90.
- They average 73.9 progressive passes per 90.
- Currently have no wide players under the age of 23, and only 3 out and out wingers in the squad.
- Team fit: 87%

Scotland Premiership

Rangers

- They average 30.95 dribbles per 90.
- They average 80.5 progressive passes per 90.
- Could be a long term replacement to Ryan Kent as he has a similar play style.
- Team fit: 85%

Aberdeen

- They average 28.3 dribbles per 90.
- They average 58 progressive passes per 90, lowest in the league.
- Goal difference of 0 despite being 3rd in the league shows their weakness defensively and offensively, where Sano would be able to add balance.
- Team fit: 85%

Celtic

- They average 29.9 dribbles per 90.
- They average 87 progressive passes per 90.
- Have a strong core of Japanese players and have historically developed some great Japanese talents.
- Currently have only 1 wide player under 23.
- Team fit: 84%



DANUBIO FC



URUGUAY

FRANCO GONZÁLEZ

SCOUT REPORT

JUNE 2023



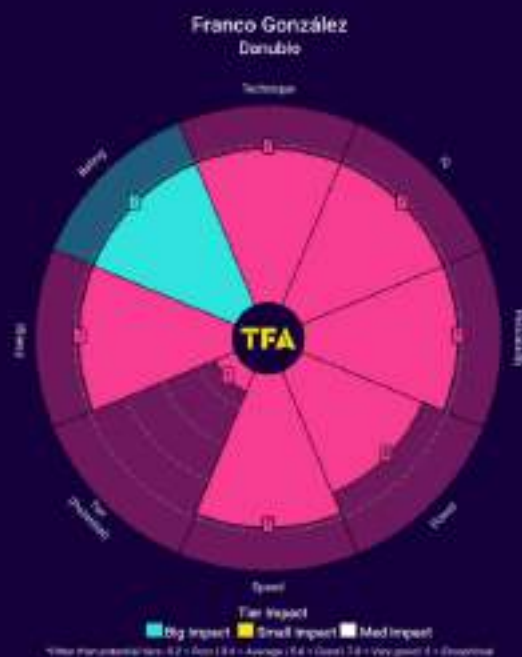

Franco González is a versatile attacking-midfielder who can play as RCM or RW as well, always looking to appear in half-spaces and in small spots of the rival block where he can receive and turn, in order to progress with his ball-carries and quick link-up plays with close teammates.

He has the talent and potential to play in Tier 1.

T - Technique I - IQ (football intelligence) P - Personality P - Power S - Speed T - Tier (potential Tier - see explainer) E - Energy
 R - Rating (Big, Medium, Small) if he moved to that Tier today

Score explanations (other than potential tiers): 0-2 = poor 3-4 = average 5-6 = good 7-8 = very good 9 = exceptional

PLAYER PROFILE

Franco González is a 19-year-old (22/06/2004) attacking-midfielder.

The Uruguayan currently plays as an attacking-midfielder for Danubio FC's in the Uruguay's top-tier.

His current market value is €800,000 according to Transfermarkt. He has a contract valid until 2025.

He's represented by Next Level Global agency.

He has been a key part of the Uruguay U-20 team, playing more than 20 matches and appearing at different tournaments, such as the recent U-20 World Cup in Argentina.

PLAYER HISTORY

Franco González is an academy youth product of Danubio FC. He made his professional debut last year.

FRANCO GONZÁLEZ HEATMAP

All games from Copa Sudamericana 2023, Primera División 2023

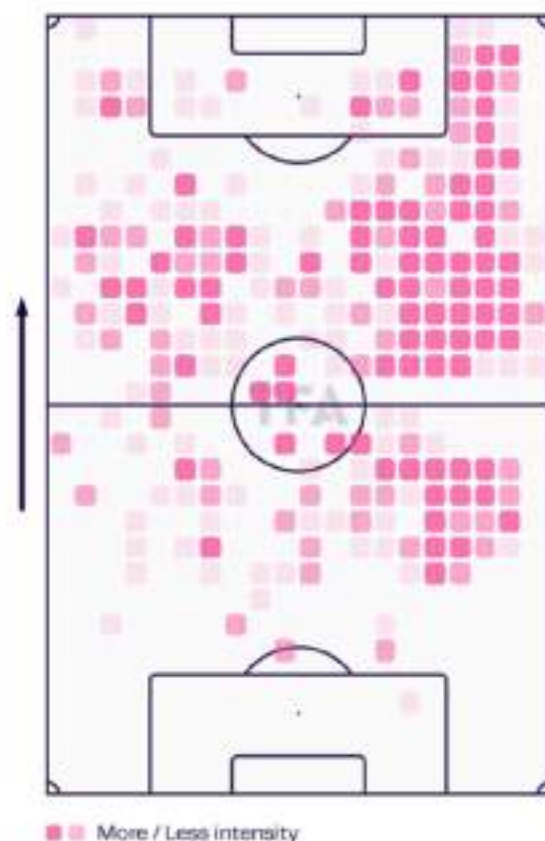

F. González | RCM | 583 minutes played
 Danubio | 18-years-old | Season 2023

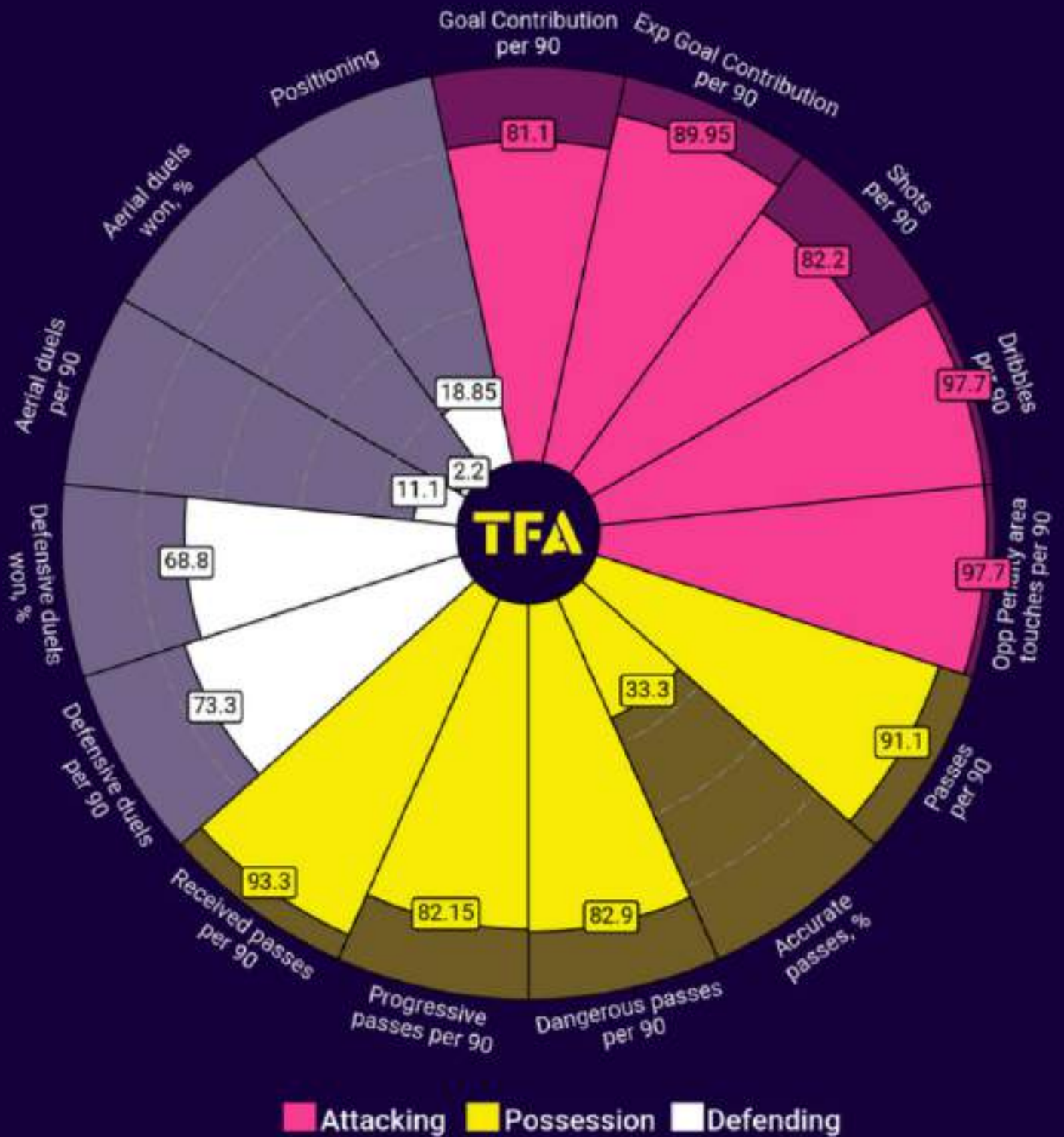

Percentile Rank vs RCMs in Uruguay-Primera Division-1 | Data from Season 2023

DEFENSIVE PHASE

He is an active player in the defensive phase of his team, showing intensity to press high in more organized situations. Detects when there may be a turnover to go steal, as well as stifle the opponent so that he throws long and his team regains possession.

Defending in lower blocks he has decent positioning, intercepting passing lanes and opponent's executions. He is also aggressive to go cut a player who receives between the lines, with certain things to improve in his defensive awareness.

He counter-presses heavily, committing with discipline to win the ball back automatically. His tackle technique can be irregular, generating fouls for being out of time.

FRANCO GONZÁLEZ DEFENSIVE TERRITORY

All games from Copa Sudamericana 2023, Primera División 2023

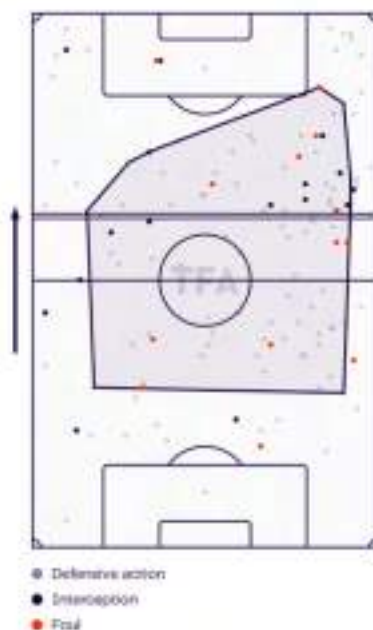

FRANCO GONZÁLEZ HIGH REGAINS

All games from Copa Sudamericana 2023, Primera División 2023



ATTACKING PHASE

He displays his football in a fairly free role, when he plays as an AM/RCM or even as a RW, where he usually uses half-spaces and approaches the play from side to side. He has smart and dynamic off-the-ball moves that allow him to receive the ball at different heights and in pockets of space where his receptions are dangerous.

He is a key player in the progression of his team, approaching the middle third to receive and make quick and short plays with his teammates, as well as offering support in these stages of possession with his ball-carries to advance many meters on the pitch.

He has a great ability to retain the press. His low center of gravity and good use of his physicality to escape from the opponent make him a slippery player, which is difficult to defend due to his agility to turn his body. His dribble is short, he seeks to attract the opponent until he tries to tackle him and it is there where González performs his actions, constantly changing pace and offering several touches to the ball when he drives. Sometimes he has to improve in terms of recognizing when to release it.

He should be more aggressive when he gets to the last third. He looks to help his team progress and release these passes prior to assists, as well as his off-the-ball moves that are clever to activate as a third man. However, he needs to evolve his end-product to contribute more with a shot or through-pass into the box.

FRANCO GONZÁLEZ PASS MAP

All games from Copa Sudamericana 2023, Primera División 2023



FRANCO GONZÁLEZ PROGRESSIVE PASSES

All games from Copa Sudamericana 2023, Primera División 2023



FRANCO GONZÁLEZ CROSSING ZONES FRANCO GONZÁLEZ WINGER ACTIONS

All games from Primera División 2023, Copa Sudamericana 2023

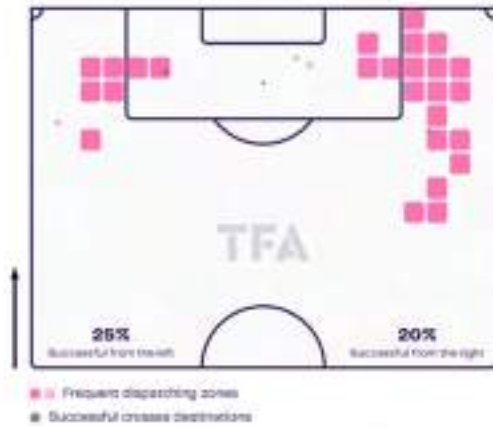

All games from Copa Sudamericana 2023, Primera División 2023



FRANCO GONZÁLEZ SHOTS

All games from Copa Sudamericana 2023, Primera División 2023



FRANCO GONZÁLEZ SHOT ASSISTS

All games from Copa Sudamericana 2023, Primera División 2023



FRANCO GONZÁLEZ PENETRATING CARRIES

All games from Copa Sudamericana 2023, Primera División 2023



TRANSITIONS

In the attacking transitions, he's a player who can command transitions in a good way, with balance in his runs, changing directions at a very high pace. However he needs to be more threatening with his end-product.

In the defensive transitions, he's intense and energetic to track back and counter-press. He's smart to rearm the block and cover his position too.

FRANCO GONZÁLEZ BALL PROGRESSION

All games from Copa Sudamericana 2023, Primera División 2023.



PHYSICAL PROFILE

Franco González stands at 165cm | 5'4. He possess a low center of gravity with an agile and elastic hip that allows him to be slippery with his body-turns. He has a lean build that uses in a great way to hold players to then turn them, however he needs to keep working on his lower-body.

In the other hand, he's very fast on-the-ball especially, with some stamina issues to keep improving.

SIMILAR PLAYERS USING XGOLD

xGOLD is our custom-built in-house tool that uses data to match player profiles

Morgan Sanson

Strasbourg
86% match

Fabio Miretti

Juventus
86% match

Joe Willock

Newcastle United
80% match



CLUB MATCHING METHODOLOGY

Our custom-built xGOLD tool has the ability to match players to clubs from a data-driven tactical fit perspective - we then take the initial shortlist and go into further scout-led filtering, considering the key points below.

A) Playing Style

Assessing teams by their playing style and finding a suitable match for González: possession-based teams that can activate him between the lines constantly.

B) Leagues

We are looking at options at teams in Germany and Italy.

C) Statistics

Players statistically similar to Franco González and whose contracts are ending and he could replace.

Germany Bundesliga

Eintracht Frankfurt

- Daichi Kamada and Jesper Lindstrom will leave next summer, opening a spot for him.
- They average 408.38 passes per 90.
- Progressive team who looks to connect with players between the lines.
- 75% match with Lindstrom in xGOLD.
- 74% fit in TeamFit.

Stuttgart

- Progressive team who looks to connect with players between the lines.
- Fit as a more advanced RCM or AMF.
- They average 407.11 passes per 90.
- 79% match with Enzo Millot in xGOLD.
- 72% fit in TeamFit.

Hoffenheim

- He can fit as a LCM/RCM in their midfield-three with progressive between-the-lines ideas.
- They average 362.3 passes per 90.
- 73% match with Finn Ole Becker in xGOLD.
- 70% fit in TeamFit.

Italy Serie A

Udinese

- They average 408.38 passes per 90.
- Progressive team who looks to connect with players between the lines, especially with their CMs.
- 73% match with Lovrič in xGOLD.
- 73% fit in TeamFit.

Lazio

- He fits massively inside their possession-based idea as an advanced RCM or LCM.
- They average 478.39 passes per 90, second-most in the league.
- 79% match with Enzo Millot in xGOLD.
- 72% fit in TeamFit.



MILLONARIOS



COLOMBIA

OSCAR CORTÉS

SCOUT REPORT

JUNE 2023



Óscar Cortés

Millonarios

Category	Description	Points
International Appearances	No data	0
Domestic Minutes	Band 4: 4%	0
Continental Minutes	No data	0
League Position	Millonarios: Colombia Categoria Primera A - Band 1 Qualifiers	0
Continental Progression	No data	0
League Quality	Liga BetPlay	6
Total	Ineligible	7

This calculation is based on rules agreed by the FA and the Home Office for players to play in England. There will be edge cases and different interpretations. Our Governing Body Endorsement (GBE) status tool should be used as a guide to assess the likelihood of a player meeting the criteria, rather than a definitive assessment. GBE criteria are regularly reviewed by the FA and Home Office. Any changes will be incorporated into our calculations when they are announced.

NB: Our calculations don't currently take into account injury data or, for players under 21, any additional points from the youth criteria. There are variations to the GBE criteria for players to play in Scotland and details can be found on the Scottish FA website.

TFA



Óscar Cortés, at 19 years of age, is a LW/LAMF with very advanced technical-tactical attributes, with the potential to be one of the most decisive wingers of his generation. He is a very complete player with a great amount of offensive resources to create scoring chances.

He is a player who exhausts his opponents physically and mentally due to how difficult he is to defend in 1v1, as he can overcome through speed, dribbles or short connections with his teammates and then move into free spaces.

Due to his age and current level, Óscar Cortés could play in a Tier 1 league in the short term.

T = Technique I = IQ (football intelligence) P = Personality P = Power S = Speed T = Tier (potential Tier - see explainer) E = Energy R = Rating (Big Medium Small) if he moved to that Tier today

Score explanations (other than potential tiers): 0-2 = poor 3-4 = average 5-6 = good 7-8 = very good 9 = exceptional

PLAYER PROFILE

Óscar Cortés is a 19-year-old (15/11/2005) left-winger. He's right-footed.

The Colombian is currently playing for Millonarios in the Liga Dimayor I, Colombia's top tier.

He has already been called up to the Colombia National Team, however he has been a key part of the U20s side which participated in the 2023 U20 World Cup.

His current value on Transfermarkt is €1,500,000. He has a contract valid until 2025.

PLAYER HISTORY

Óscar Cortés has played his entire career at Millonarios.

Ó. CORTÉS HEATMAP

All games from Copa Sudamericana 2023, Copa Libertadores 2023, Liga BetPlay 2023, Sudamericano U20 2023 Colombia

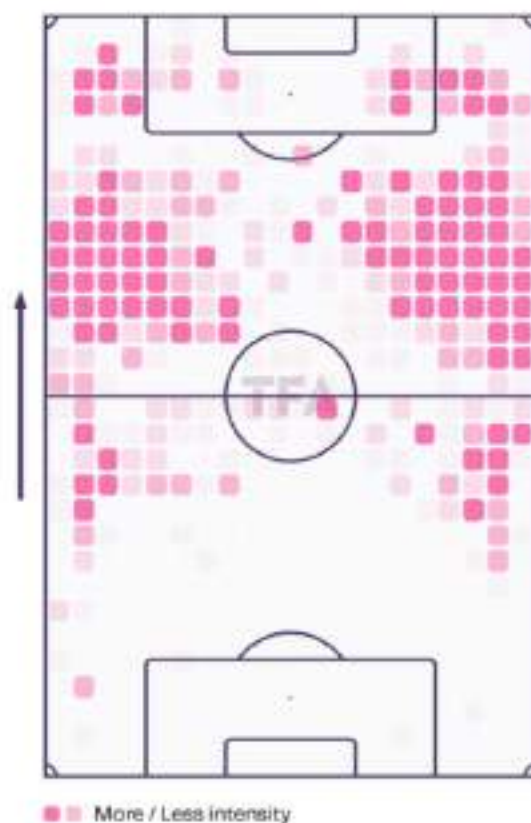

Ó. Cortés | AMF | 464 minutes played
Millonarios | 19-years-old | Season 2023

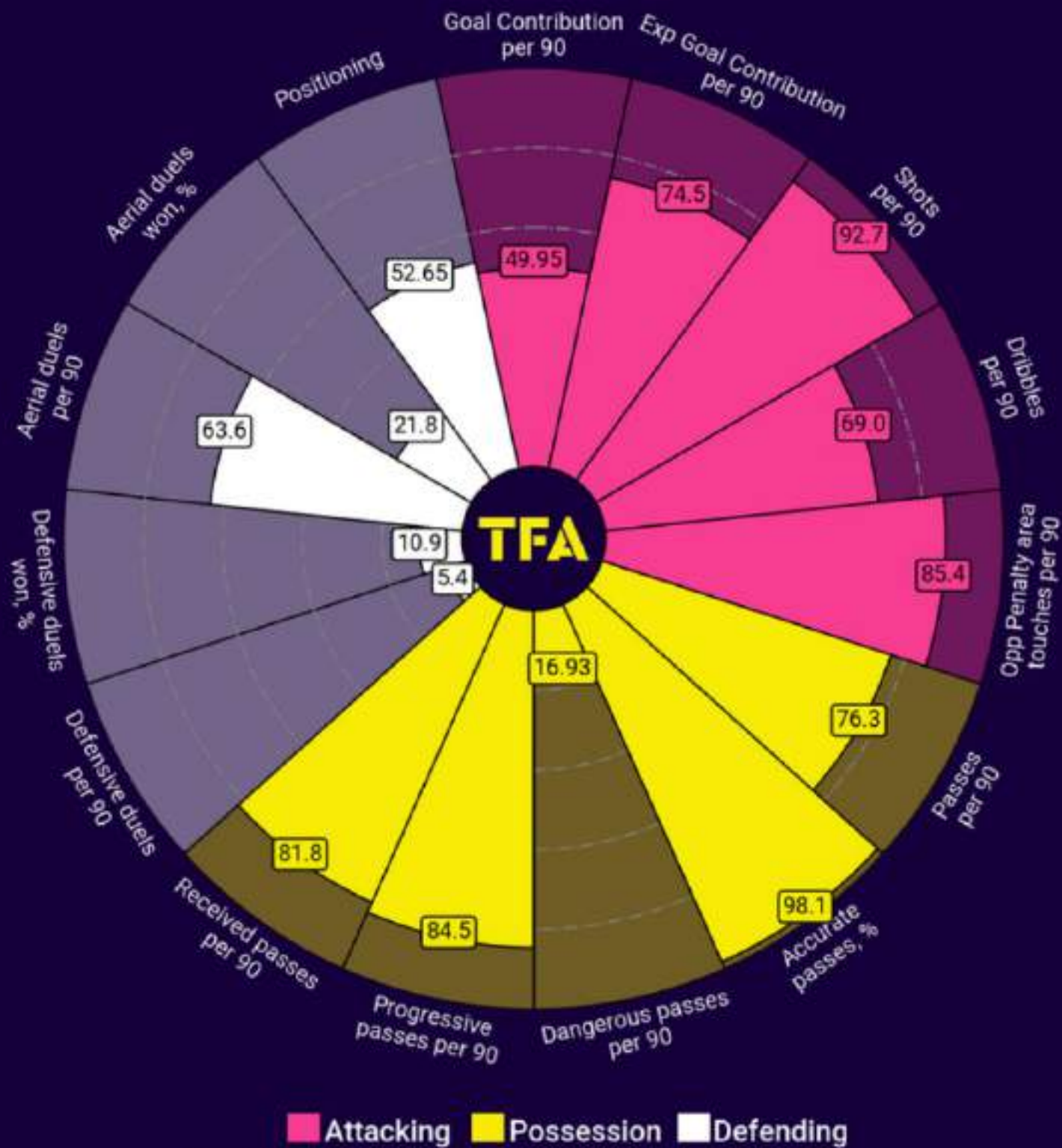

Percentile Rank vs AMFs in Colombia-Liga BetPlay-1 | Data from Season 2023

DEFENSIVE PHASE

He's a player of intense and good tactical understanding to press high, with a good direction of his runs to cover passing lanes as well as intercept the rival's executions to later counter-attack.

His work-ethic is decent. He recognizes how to adapt to lower team positions, between low and mid, as well as high.

He's a better defender when he performs these actions as a winger, rather than as an AM, where he shows his aggressiveness to go from the outside to the inside, marking CBs or GKs.

Ó. CORTÉS DEFENSIVE TERRITORY

All games from Copa Sudamericana 2023, Copa Libertadores 2023, Liga BetPlay 2023, Sudamericano U20 2023 Colombia, South American Youth Games 2022 Paraguay

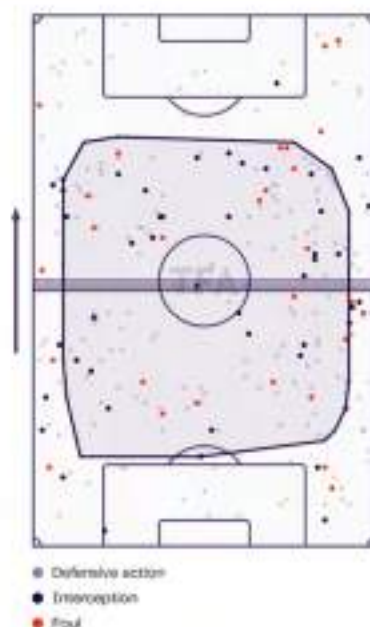

Ó. CORTÉS HIGH REGAINS

All games from Copa Sudamericana 2023, Copa Libertadores 2023, Liga BetPlay 2023, Sudamericano U20 2023 Colombia, South American Youth Games 2022 Paraguay



ATTACKING PHASE

He is a player who offers versatility to play as an AM or wide winger, where he likes to constantly receive to later cut inside as well as offer explosiveness to go outside. He generates in-behind movements, especially looking for the blind-side of the rival FB. He is dynamic off-the-ball, creating chances purely through it.

He has reliable link-up play that allows him to play half-spaces and central channels when he starts matches as an AM. His touches are of a good level of sensitivity, generating subsequent pace-changes of great explosiveness.

His dribbling is creative. He utilizes his low center of gravity well and is agile to turn/escape from tight spaces while being slippery with his speed and close-control.

He is aggressive when he approaches the opponent's penalty area. He can display his ability to shoot from long range as well as finish off actions with well-adjusted short shots close to the goalkeeper.

Ó. CORTÉS WINGER ACTIONS

All games from Copa Sudamericana 2023, Copa Libertadores 2023, Liga BetPlay 2023, Sudamericano U20 2023 Colombia



Ó. CORTÉS CROSSING ZONES

All games from Copa Sudamericana 2023, Copa Libertadores 2023, Liga BetPlay 2023, Sudamericano U20 2023 Colombia



Ó. CORTÉS SHOT ASSISTS

All games from Copa Sudamericana 2023, Copa Libertadores 2023, Liga BetPlay 2023, Sudamericano U20 2023 Colombia, South American Youth Games 2022 Paraguay

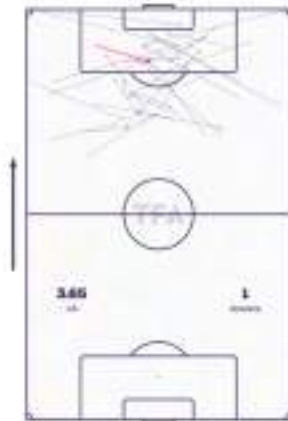

/// Shot assist / Assist

Ó. CORTÉS SHOTS

All games from Copa Sudamericana 2023, Copa Libertadores 2023, Liga BetPlay 2023, Sudamericano U20 2023 Colombia



Ó. CORTÉS PASS MAP

All games from Copa Sudamericana 2023, Copa Libertadores 2023, Liga BetPlay 2023, Sudamericano U20 2023 Colombia, South American Youth Games 2022 Paraguay

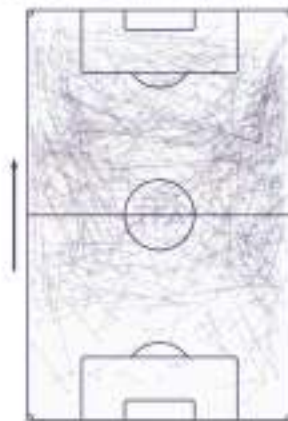

/// Successful pass

Ó. CORTÉS PROGRESSIVE PASSES

All games from Copa Sudamericana 2023, Copa Libertadores 2023, Liga BetPlay 2023, Sudamericano U20 2023 Colombia, South American Youth Games 2022 Paraguay



/// Progressive pass
/// Progressive pass into the penalty area

Ó. CORTÉS PENETRATING CARRIES

All games from Copa Sudamericana 2023, Copa Libertadores 2023, Liga BetPlay 2023, Sudamericano U20 2023 Colombia



/// Carry
/// Carry into the penalty area

TRANSITIONS

In the attacking transitions, he's a highly creative player when receiving in transitions, usually on wide-channels. There, he demonstrates his physical and technical ability to accelerate powerfully in his stride and maintain good balance in his runs and with the ball-close to his feet.

In the defensive transitions, he's an active defender to counter-press and track back, helping his teammates in situations of numerical inferiority.

Ó. CORTÉS BALL PROGRESSION

All games from Copa Sudamericana 2023, Copa Libertadores 2023, Liga BetPlay 2023, Sudamericano U20 2023 Colombia, South American Youth Games 2022 Paraguay



PHYSICAL PROFILE

Oscar Cortés stands at 176cm, uses his low center of gravity in an excellent way, retaining pressure and turning elastically to evade it. It's not the most imposing and big build but the ability of him to take advantages of his physicality and short stature is a top attribute of his game.

On the other hand, he's explosive on and off the ball, with solid pace, as well as decent stamina.

CLUB MATCHING METHODOLOGY

Our custom-built xGOLD tool has the ability to match players to clubs from a data-driven tactical fit perspective - we then take the initial shortlist and go into further scout-led filtering, considering the key points below.

A) Playing Style

Assessing teams by their playing style and finding a suitable match for Cortés: teams that can activate him on the wing and approach players to create quick-plays.

B) Leagues

We are looking at options at teams in France and Spain.

C) Statistics

Players statistically similar to Oscar Cortés and whose contracts are ending and he could replace.

Spain La Liga

Villarreal CF

- Team that normally look to drive their attacking-threat through their direct and explosive wingers.
- They average 27.35 dribbles per 90.
- Can be a good team to evolve in the short-medium-long term.

Real Sociedad

- Possession-based that tends to look their wingers to bring explosiveness and creativity to attack.
- They average 22.52 dribbles per 90.

France Ligue 1

Lorient

- Team that is losing their threatening players and should be in the market.
- He fits inside their direct idea from wingers, getting short and quick link-up with their #10.
- They average 28.50 dribbles per 90.

Nantes

- Can be a big impact player as he can provide more threat from the flanks than Ludovic Blas has give to the club, making them dependant on him.
- They average 28.21 dribbles per 90.

Stade Reims

- He can fit inside the wingers' roles within the team's tactics, as they look to play in wide and half-spaces, playing short and quick, but as well dynamizing with their explosiveness.
- They average 25.67 dribbles per 90.



DEFENSOR



URUGUAY

SCOUT REPORT

MATÍAS ABALDO

JUNE 2023



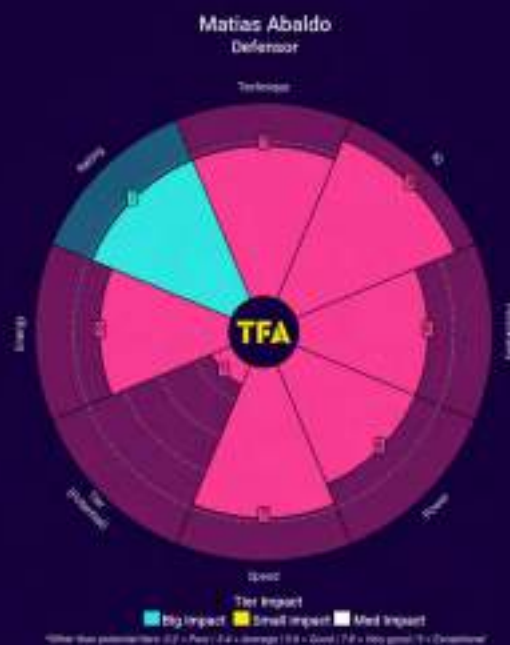

Matias Abaldo is a RW of inventive dribbling, who carries an extremely fine and elegant technique, eluding opponents in slow-motion as well as changing his pace in a more explosive and dynamic manner. He is aggressive to generate shots and technical to break lines with through-passes.

He has potential to play in Tier 1.

T - Technique I - IQ (football intelligence) P - Personality P - Power S - Speed T - Tier (potential Tier - see explainer) E - Energy
 R - Rating (Big, Medium, Small) if he moved to that Tier today

Score explanations (other than potential tiers): 0-2 = poor 3-4 = average 5-6 = good 7-8 = very good 9 = exceptional

PLAYER PROFILE

Matias Abaldo is a 19-year-old (02/04/2004) right-winger.

He is left-footed and currently plays for Defensor in the Uruguayan's top tier. He's German and Uruguayan as well.

His current market value is €500,000 according to Transfermarkt. He has a contract valid until 2024.

He has been a key part of the U20 Uruguay's National Team, being part of the 2023 U20 World Cup.

PLAYER HISTORY

Matias Abaldo has developed inside Defensor his entire career.

M. ABALDO HEATMAP

All games from Primera División 2023, Copa Sudamericana 2023, Primera División 2022

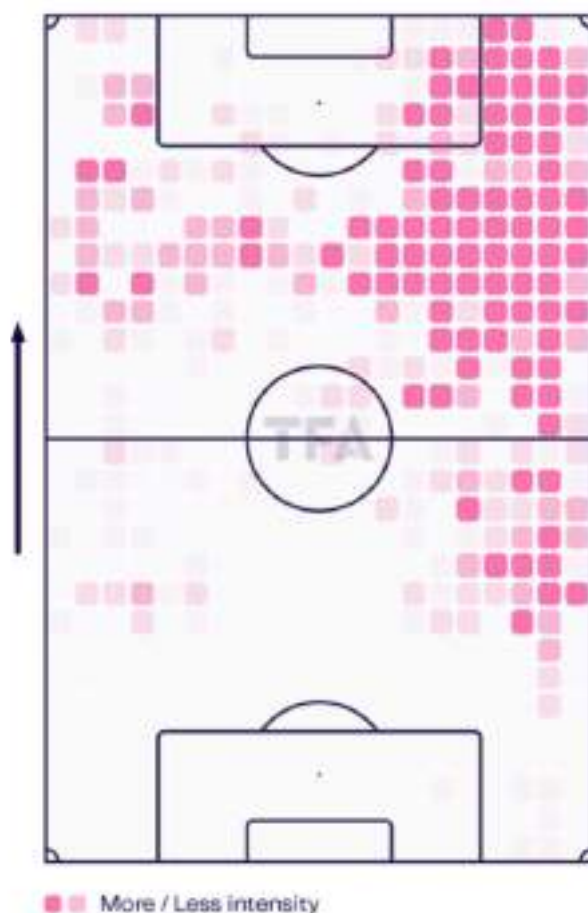

M. Abaldo | RW | 782 minutes played
 Defensor Sporting | 19-years-old | Season 2023

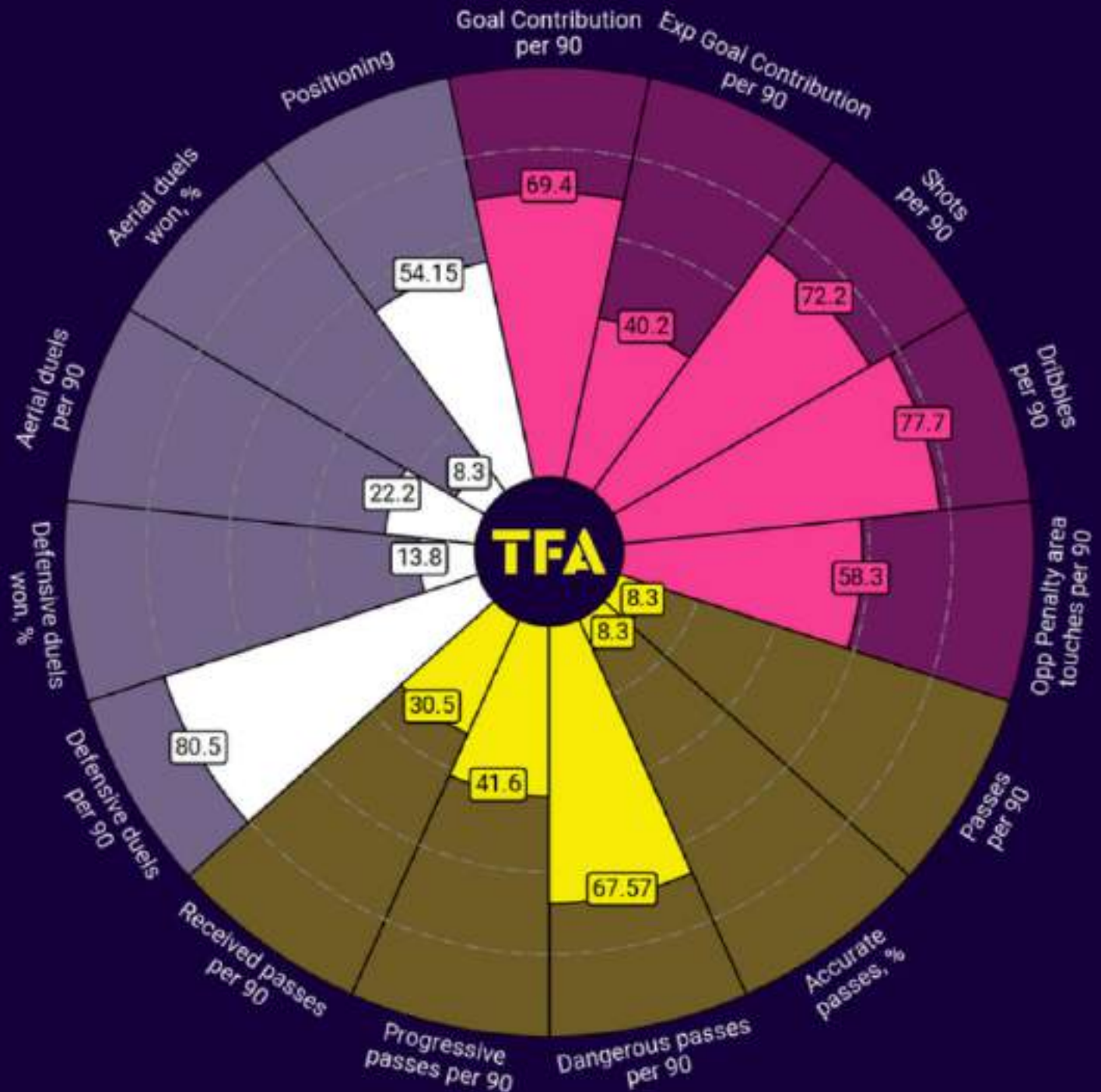

Attacking Possession Defending

Percentile Rank vs RWs in Uruguay-Primera Division-1| Data from Season 2023

DEFENSIVE PHASE

In the defensive phase of the game, Matias Abaldo is a player of great intensity and energy to press high as a winger. He duels constantly and is a good ball-winner.

He intercepts passes through his decent positioning, anticipating opponent decisions and turnovers, as well as blocks passing lanes.

He regularly commits to defending in lower blocks, with some tactical maturity to adopt in the mid-term.

M. ABALDO DEFENSIVE TERRITORY

All games from Copa Sudamericana 2023, Primera División 2023, Primera División 2022

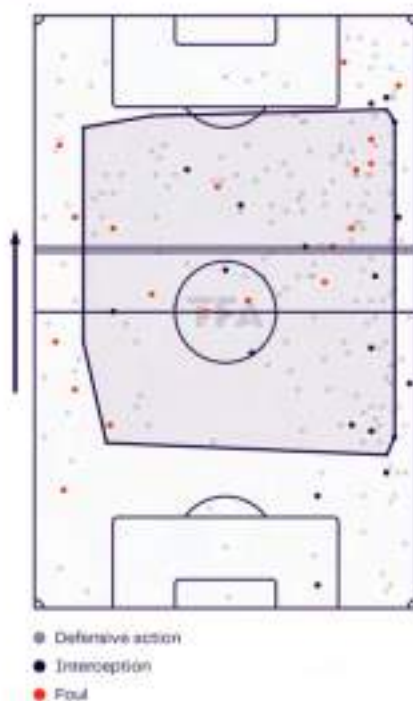

M. ABALDO HIGH REGAINS

All games from Primera División 2023, Copa Sudamericana 2023, Primera División 2022

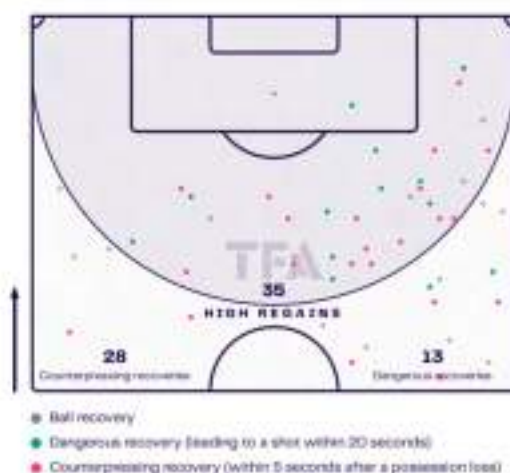

ATTACKING PHASE

He is a player who normally receives wide open on the right side of the pitch, opens his left-foot to later face the opponent going to the inside or out, with a lot of inventiveness on his part.

He possesses a short link-up play of great technical quality, as well as a solid ability to generate through-passes, finding teammates that are going in-behind, surprising opposing defensive lines with his vision and exact weight executions.

His dribbling is very creative, supported by his low center of gravity to escape tight-spaces, either with an explosive pace-change as well as turns and elastic movements + short-dribbling close to his feet, to avoid rivals in slow-motion.

He is aggressive to enter the box from outside to inside and finish with power.

M. ABALDO WINGER ACTIONS

All games from Copa Sudamericana 2023, Primera División 2023, Primera División 2022



M. ABALDO CROSSING ZONES

All games from Copa Sudamericana 2023, Primera División 2023, Primera División 2022



M. ABALDO SHOTS

All games from Copa Sudamericana 2023, Primera División 2023, Primera División 2022



M. ABALDO SHOT ASSISTS

All games from Copa Sudamericana 2023, Primera División 2023, Primera División 2022



M. ABALDO PROGRESSIVE PASSES

All games from Copa Sudamericana 2023, Primera División 2023, Primera División 2022

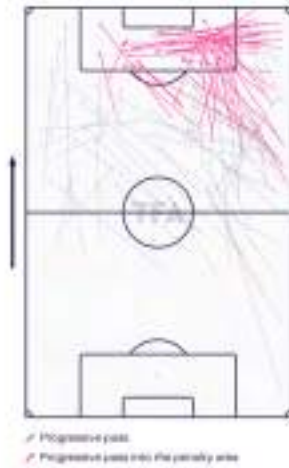

M. ABALDO PASS MAP

All games from Copa Sudamericana 2023, Primera División 2023, Primera División 2022



M. ABALDO PENETRATING CARRIES

All games from Copa Sudamericana 2023, Primera División 2023, Primera División 2022

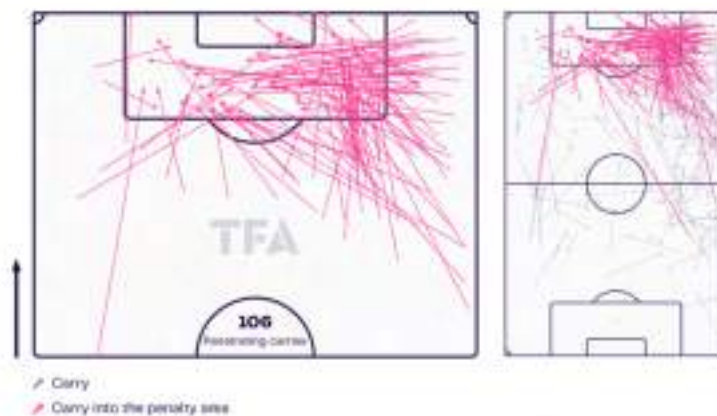

TRANSITIONS

In transitions from defense to attack, he is a threatening player who can generate a variety of off-the-ball moves to receive the ball and shoot, as well as having the ability, and at the top of his game, to generate through-passes in rapid attacks.

He's a player of intensity and energy to track back, reach opponents and participate in defensive transitions.

M. ABALDO BALL PROGRESSION

All games from Copa Sudamericana 2023, Primera División 2023, Primera División 2022



PHYSICAL PROFILE

Matias Abaldo stands at 172cm, he possess a low center of gravity which uses in a great way to retain the ball with his short-dribbling and elastic movements that allows him to be fast and as well create dribbles in a slow manner.

He possess decent pace, stamina and intensity to act in both phases.

CLUB MATCHING METHODOLOGY

Our custom-built xGOLD tool has the ability to match players to clubs from a data-driven tactical fit perspective - we then take the initial shortlist and go into further scout-led filtering, considering the key points below.

A) Playing Style

Assessing teams by their playing style and finding a suitable match for Abaldo: teams that look to activate their wingers to be threatening.

B) Leagues

We are looking at options at teams in France and Spain.

C) Statistics

Players statistically similar to Matias Abaldo and whose contracts are ending and he could replace.

France Ligue 1

Olympique Lyonnais

- A team that looks their wingers to bring the threat with creative dribbling.
- TeamFit shows a match of 81%.
- 84% similarity with Rayan Cherki, according to xGOLD.
- They average 28.20 dribbles per 90.

Stade Rennes

- Can fit inside the team's tactics as they look to play with dynamic and creative dribbling-wingers.
- They average 25.53 dribbles per 90.
- 81% similarity with Jeremy Doku, according to xGOLD.
- TeamFit shows a match of 83%.

Spain La Liga

Sevilla

- Team where he can fit as they look their wingers to be creative with their dribbling and aggressive to shoot.
- They average 21.30 dribbles per 90.
- TeamFit shows a match of 81%.
- xGOLD shows a similarity of 82% and 81% respectively with Suso and 'Papu' Gomez.

Valencia

- He can fit as a wide-winger, as they usually look to provide the threat from the wings.
- They average 27.30 dribbles per 90.
- TeamFit shows a match of 81%.
- 81% of similarity with Samu Castillejo, according to xGOLD.

Osasuna

- Direct team that looks to provide threat from the wings. He could be a big impact signing in the short-mid-long term.
- TeamFit shows a match of 80%.
- They average 21.1 dribbles per 90.
- 81% similarity with Kike Barja, according to xGOLD.



CA ROSARIO CENTRAL



ARGENTINA

SCOUT REPORT

ALEJO VÉLIZ

JUNE 2023



Alejo Véliz CA Rosario Central

Category	Description	Points
International Appearances	No data	0
Domestic Minutes	Band 3: 64%	5
Continental Minutes	No data	0
League Position	Rosario Central: Argentina Superliga - #23	
Continental Progression	No data	0
League Quality	Liga Profesional de Fútbol	8

Total

Exceptions Panel

13

This calculation is based on rules agreed by the FA and the Home Office for players to play in England. There will be edge cases and different interpretations. Our Governing Body Endorsement (GBE) status tool should be used as a guide to assess the likelihood of a player meeting the criteria, rather than a definitive assessment. GBE criteria are regularly reviewed by the FA and Home Office. Any changes will be incorporated into our calculations when they are announced.

NB: Our calculations don't currently take into account injury data or, for players under 21, any additional points from the youth criteria. There are variations to the GBE criteria for players to play in Scotland and details can be found on the Scottish FA website.

TFA

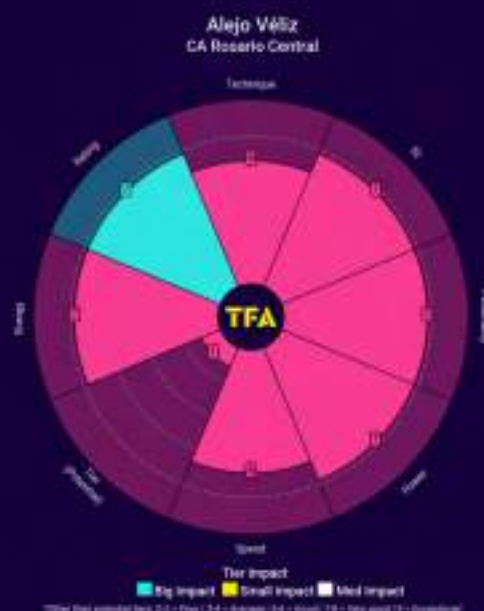

Alejo Véliz is a young striker who has the basic traits of a capable modern day targetman. He was solid during link up play and showcased good strength on the ball while also managing to hold it effectively under pressure. He did show some promise with his dribbles but does need to be more unpredictable with his footwork here. Véliz was a competent finisher and often did well to hit the target from range but needs to do more to warrant himself as a creative figure. He was capable of pressing in a high line and often pressured opponents into conceding mistakes but can be a little more diligent when trying to track back into his box.

T = Technique I = IQ (football intelligence) P = Personality P = Power S = Speed T = Tier (potential Tier - see explainer) E = Energy
R = Rating (Big, Medium, Small) if he moved to that Tier today

Score explanations (other than potential tiers): 0-2 = poor 3-4 = average 5-6 = good 7-8 = very good 9 = exceptional

PLAYER PROFILE

Alejo Véliz is a 19-year-old Argentine footballer who plays as a centre forward for Rosario Central in the Liga Profesional which is the first tier of Argentine football.

He is predominantly right-footed and also looked capable of playing as a left flank as well. He is a current U20 Argentine international.

Véliz has a current market value of €4,000,000.

PLAYER HISTORY

Véliz is a product of the Rosario Central academy and moved to the senior side in the 22/23 season.

A. VÉLIZ HEATMAP

All games from Liga Profesional de Fútbol 2023

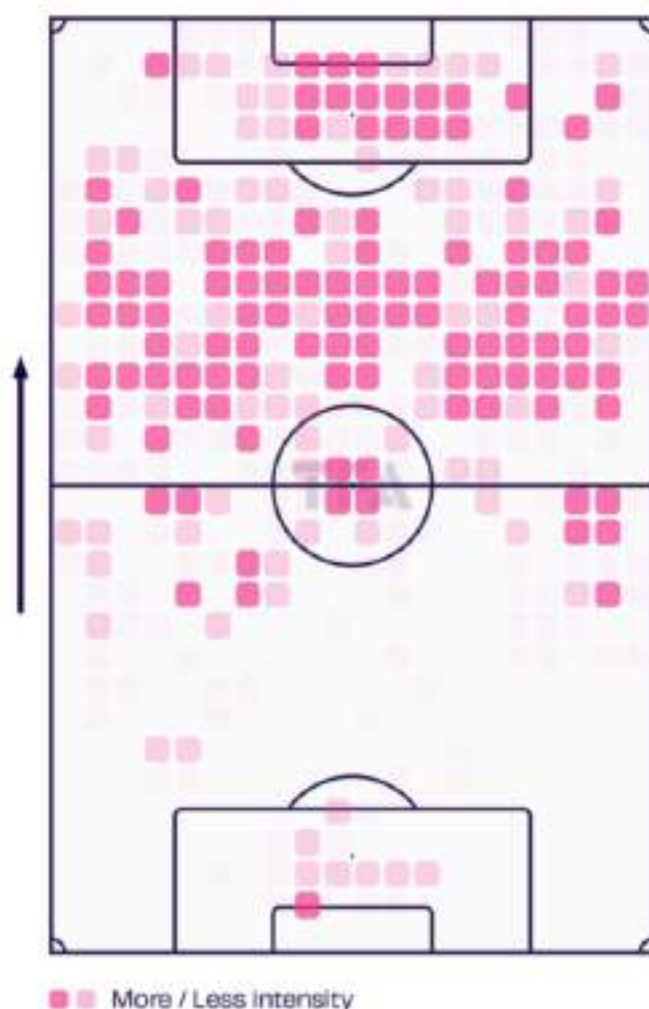

A. Véliz | CF | 1111 minutes played
Rosario Central | 19-years-old | Season 2023

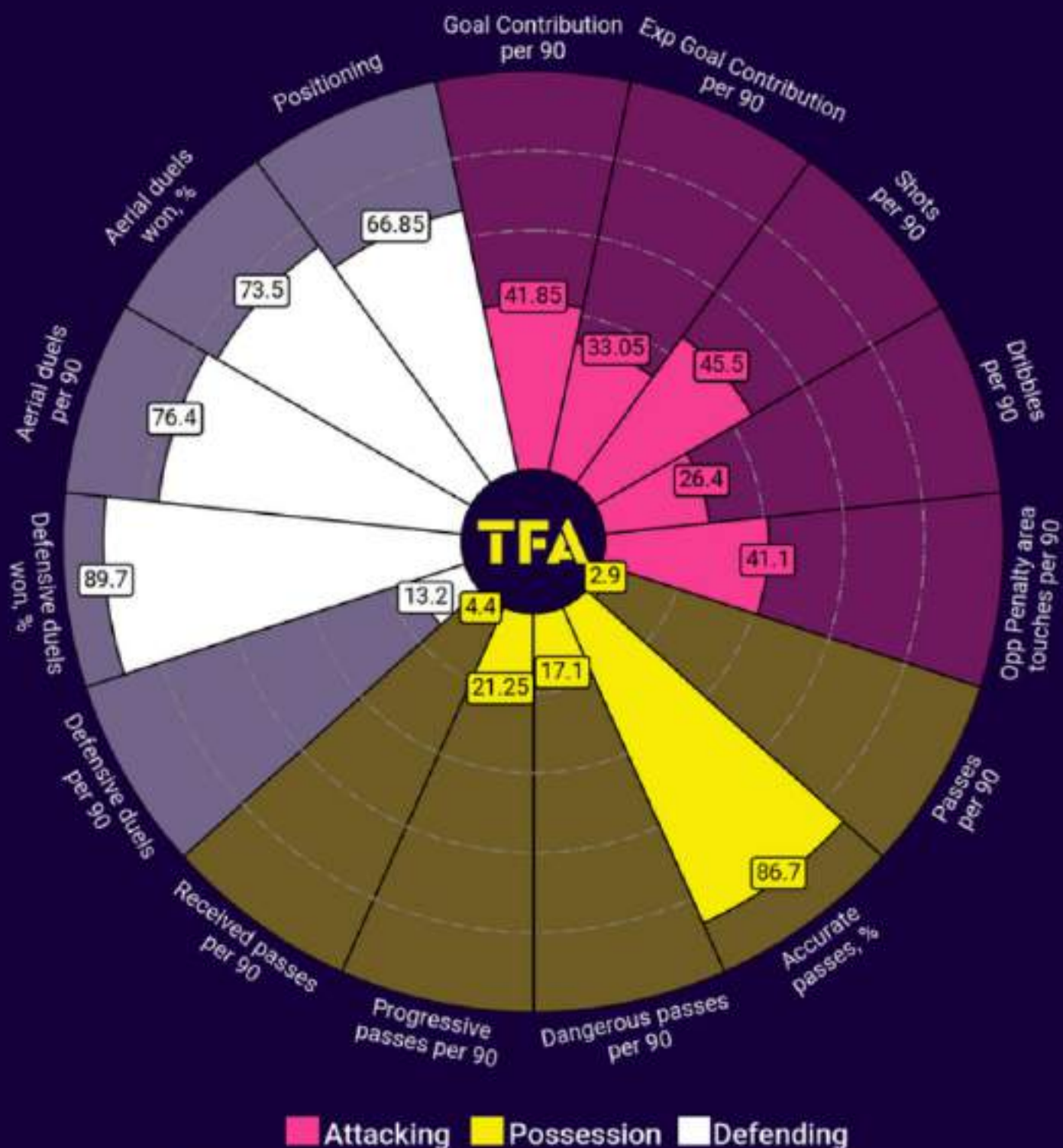

Percentile Rank vs CFs in Argentina-Liga Profesional-1 | Data from Season 2023

DEFENSIVE PHASE

Véliz did look capable of pressing in a high line and showcased an amicable level of aggression where when doing so. He was quick to close down opponents and showcased a decent work ethic when having to react to the side conceding possession here. Véliz can do a better job of nicking the ball away here though as he seemed to be more adept at pressuring the opposition into making mistakes at the moment.

Véliz almost never looked to track back and restricted most of his offensive efforts to within the opposition area. He did make a few recovery runs through the center but lacked any consistency here as well and seemed best suited to playing in an all out attacking role.

A. VÉLIZ DEFENSIVE TERRITORY

All games from Liga Profesional de Fútbol 2023

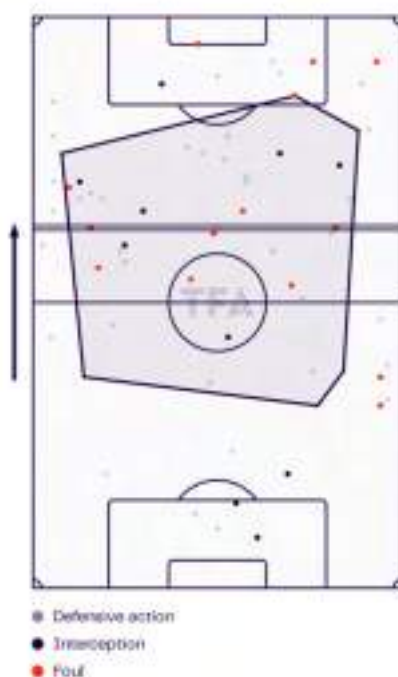

A. VÉLIZ HIGH REGAINS

All games from Liga Profesional de Fútbol 2023



ATTACKING PHASE

Véliz looked to possess an excellent first touch and does a tidy job of receiving possession under pressure. He also looked fairly strong when having to hold off opponents and looked to possess the basic trait of a competent targetman.

Véliz was an extremely competent finisher and often did well to calmly slot the chances he got into the back of the net. He showcased strong off ball movement and constantly managed to move into the opposition box unmarked, while also doing a decent job of creating a passing outlet here during transitions.

He did seem eager to carry possession forward on his own but needs to be a little sharper here. He showcased decent bursts of pace when doing so but looked to overly reliant on this factor when carrying the ball although he does an excellent job of shielding it when on the move while also showcasing good strength to stay on his feet here.

Véliz also looked to be a potent threat from set pieces and looked dangerous in the air. He showcased a strong leap and did well to make clean contact with the ball here while also managing to test the keeper from range.

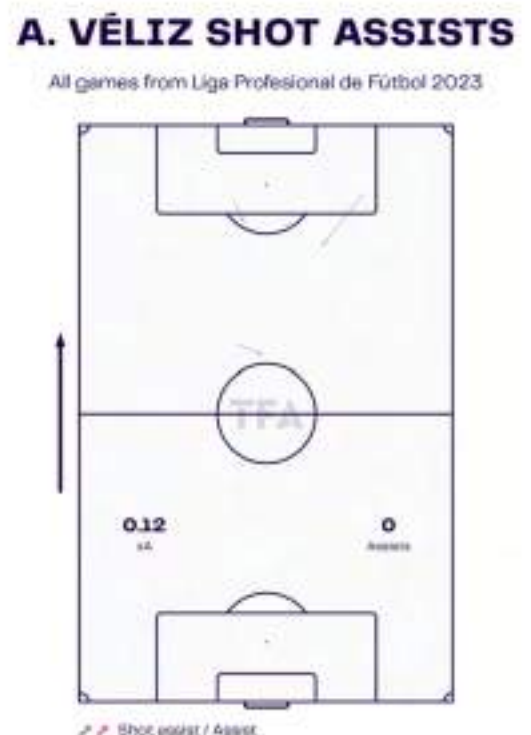

A. VÉLIZ PASS MAP

All games from Liga Profesional de Fútbol 2023



➤ Successful pass

A. VÉLIZ PROGRESSIVE PASSES

All games from Liga Profesional de Fútbol 2023



➤ Progressive pass

➤ Progressive pass into the penalty area

A. VÉLIZ PENETRATING CARRIES

All games from Liga Profesional de Fútbol 2023



➤ Carry

➤ Carry into the penalty area

TRANSITIONS

Véliz was a lively figure during the side's offensive transition as his mobility stood out here. He does well to cut in between the opposition line and often looked to create passing outlets inside the opposition box. He also looked solid during link up play and did well to hold onto the ball in tight spaces but can be a little more effective when trying to release the ball here.

Véliz did not seem to be overly involved in the side's defensive transitions but did look purposeful when trying to press in a high line. He was aggressive when going down opponents and often pressured them into making mistakes while also looking to be alert to runners in his close proximity. Despite this, he never really seemed eager to track back and often restricted most of his defensive efforts to within the opposition area.

A. VÉLIZ BALL PROGRESSION

All games from Liga Profesional de Fútbol 2023



PHYSICAL PROFILE

Standing at a fairly solid height of 187 cm, Véliz was competent in the air and looked to be a threat from set pieces. He also did well to help clear the ball during opposition corners and showcased a strong leap here.

Véliz had a lean build but seemed to be very mobile as well for a player of his size. He looked agile on the ball as well and showcased good bursts of pace to move the ball away from his marker.

Véliz looked to be a physically dominant player and this was often reflected in his attacking duels. He does an excellent job of holding off opposition pressure during transitions and rarely went down under pressure here.

SIMILAR PLAYERS USING XGOLD

xGOLD is our custom-built in-house tool that uses data to match player profiles

Ollie Watkins

Aston Villa F.C.

84% match

Marcus Thuram

Borussia Mönchengladbach

80% match

Youssef En-Nesyri

Sevilla FC

80% match



CLUB MATCHING METHODOLOGY

Our custom-built xGOLD tool has the ability to match players to clubs from a data-driven tactical fit perspective - we then take the initial shortlist and go into further scout-led filtering, considering the key points below.

A) Playing Style

Assessing teams by their playing style and finding a suitable match for Véliz: Teams who average a low number of aerial duels and low pass success rates,

B) Leagues

We are looking at options from German Bundesliga, French Ligue 1, Italy Serie A, Dutch Eredivisie and Belgian Pro League

C) Statistics

Players who are statistically similar to Véliz and whose contracts are ending and he could replace.

German Bundesliga

Eintracht Frankfurt

- They only average 35.79 aerial duels per 90 and need to a more dominant presence in the air.
- They have an average pass success rate of 81.8% but need to do so with progressive balls as well.
- Randal Kolo-Muani's future is uncertain at the moment.
- Teamfit match of 78%

Union Berlin

- They average 52.32 aerial duels per 90 and are a side that often looks to play route one football.
- They have an average pass success rate of 79.5% but need to do so with progressive balls as well.
- Teamfit match of 74%

Borussia M'gladbach

- They only average 29.59 aerial duels per 90 and need to a more dominant presence in the air.
- They have an average pass success rate of 85.4% but need to do so with progressive balls as well.
- Marcus Thuram is expected to leave on a free this season.
- Teamfit match of 70%

French Ligue 1

RC Lens

- They average 27.09 aerial duels per 90 and need to a more dominant presence in the air.
- They have an average pass success rate of 87.3% but need to do so with progressive balls as well.
- Need additional fire power for UCL.
- Teamfit match of 74%

LOSC Lille

- They average 29.2 aerial duels per 90 and need to a more dominant presence in the air.
- They have an average pass success rate of 87.7% but need to do so with progressive balls as well.
- Need additional attacking options with Bamba leaving and David's future uncertain.
- Teamfit match of 68%

Reims

- They average 29.03 aerial duels per 90 and need to a more dominant presence in the air.
- They have an average pass success rate of 81.5% but need to do so with progressive balls as well.
- Balogun's future is uncertain and need a promising back up.
- Teamfit match of 67%

Italy Serie A

Sassuolo

- They average 25.24 aerial duels per 90 and need to a more dominant presence in the air.
- They have an average pass success rate of 84.4% but need to do so with progressive balls as well.
- Pinamonti needs a dependable back up.
- Teamfit match of 71%

Bologna

- They average 26.82 aerial duels per 90 and need to a more dominant presence in the air.
- They have an average pass success rate of 84.8% but need to do so with progressive balls as well.
- Arnautović is on the decline and needs an upgrade.
- Teamfit match of 69%

Fiorentina

- They average 34.7 aerial duels per 90 and need to a more dominant presence in the air.
- They have an average pass success rate of 84.7% but need to do so with progressive balls as well.
- Need additional fire power for Europe.
- Teamfit match of 74%

Dutch Eredivisie

AFC Ajax

- They average 28.62 aerial duels per 90 and need to a more dominant presence in the air.
- They have an average pass success rate of 87.9% but need to do so with progressive balls as well.
- Tadic is ageing and needs a dependable back up who offers something very different.
- Teamfit match of 73%

Feyenoord

- They average 29.71 aerial duels per 90 and need to a more dominant presence in the air.
- They have an average pass success rate of 85.4% but need to do so with progressive balls as well.
- Teamfit match of 71%

PSV Eindhoven

- They average 35.36 aerial duels per 90 and need to a more dominant presence in the air.
- They have an average pass success rate of 85.4% but need to do so with progressive balls as well.

Belgian Pro League

Club Brugge

- They average 30.26 aerial duels per 90 and need to a more dominant presence in the air.
- They have an average pass success rate of 84.5% but need to do so with progressive balls as well.
- Teamfit match of 70%

Union Saint-Gilloise

- They average 30.59 aerial duels per 90 and need to a more dominant presence in the air.
- They have an average pass success rate of 82.3% but need to do so with progressive balls as well.
- Teamfit match of 77%

Westerlo

- They average 30.98 aerial duels per 90 and need to a more dominant presence in the air.
- They have an average pass success rate of 83.4% but need to do so with progressive balls as well.
- Teamfit match of 73%



SAN LORENZO



ARGENTINA

AGUSTÍN GIAY

SCOUT REPORT

JUNE 2023



Agustín Giay CA San Lorenzo de Almagro

Category	Description	Points
International Appearances	No data	0
Domestic Minutes	Band 3: 40%	3
Continental Minutes	No data	0
League Position	San Lorenzo: Argentina Superliga - Band 2 Qualifiers	0
Continental Progression	No data	0
League Quality	Liga Profesional de Fútbol	8
Total	Exceptions Panel	11

This calculation is based on rules agreed by the FA and the Home Office for players to play in England. There will be edge cases and different interpretations. Our Governing Body Endorsement (GBE) status tool should be used as a guide to assess the likelihood of a player meeting the criteria, rather than a definitive assessment. GBE criteria are regularly reviewed by the FA and Home Office. Any changes will be incorporated into our calculations when they are announced.

NB: Our calculations don't currently take into account injury data or, for players under 21, any additional points from the youth criteria. There are variations to the GBE criteria for players to play in Scotland and details can be found on the Scottish FA website.

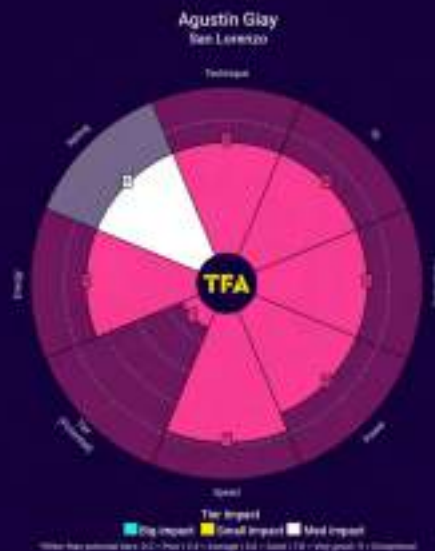

Agustín Giay is a dynamic full back who also looked capable of playing as a wing back if needed. He was very quick when going forward and often managed to get into strong areas of the pitch. Despite this, he does look raw with his decision making and final output here while also having to improve his dribbling skills. Giay looked decent on the defensive front but did show a tendency to get dragged out wide with his aggressive style of defending. He did seem competent during his 1v1 duels and often held his ground well here but does need to improve his aerial prowess though.

T = Technique I = IQ (football intelligence) P = Personality P = Power S = Speed T = Tier (potential Tier - see explainer) E = Energy
R = Rating (Big, Medium, Small) if he moved to that Tier today

Score explanations (other than potential tiers): 0-2 = poor 3-4 = average 5-6 = good 7-8 = very good 9 = exceptional

PLAYER PROFILE

Agustín Giay is a 19-year-old Argentine right back who currently plays for San Lorenzo in the Liga Profesional, the Argentine First Tier.

He is a right-footed player who can also play as a right midfielder. He is a current Argentine U20 international

Giay has a current market value of €4,000,000.

PLAYER HISTORY

Agustin came through the ranks of the San Lorenzo youth team and settled in with their senior side in the 22/23 season. He has represented Argentina at the U15, U16 and U20 levels as well.

A. GIAY HEATMAP

All games from Liga Profesional de Fútbol 2023

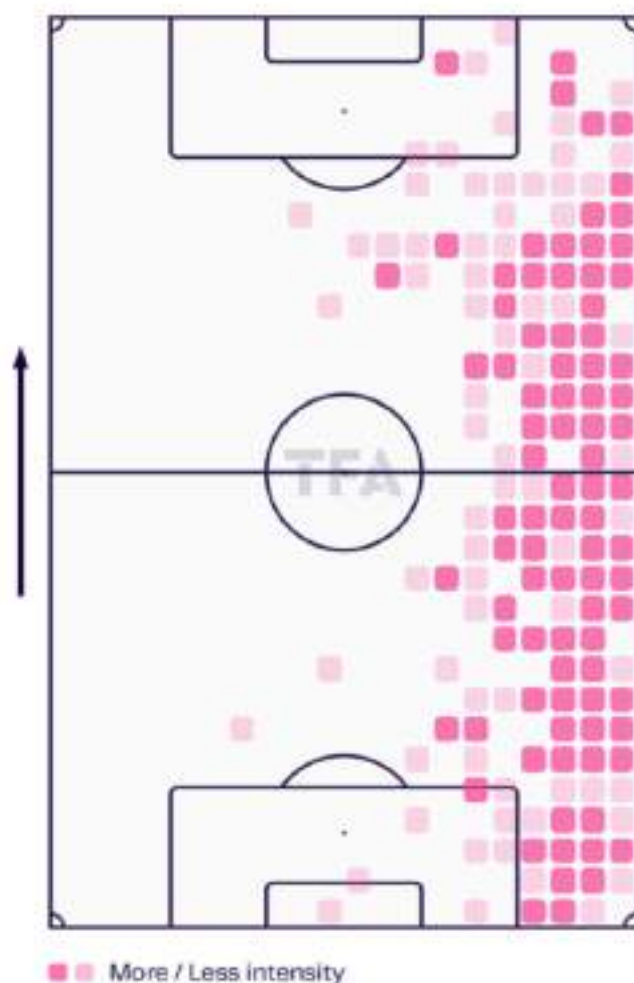

A. Giay | RWB | 474 minutes played
 San Lorenzo | 19-years-old | Season 2023

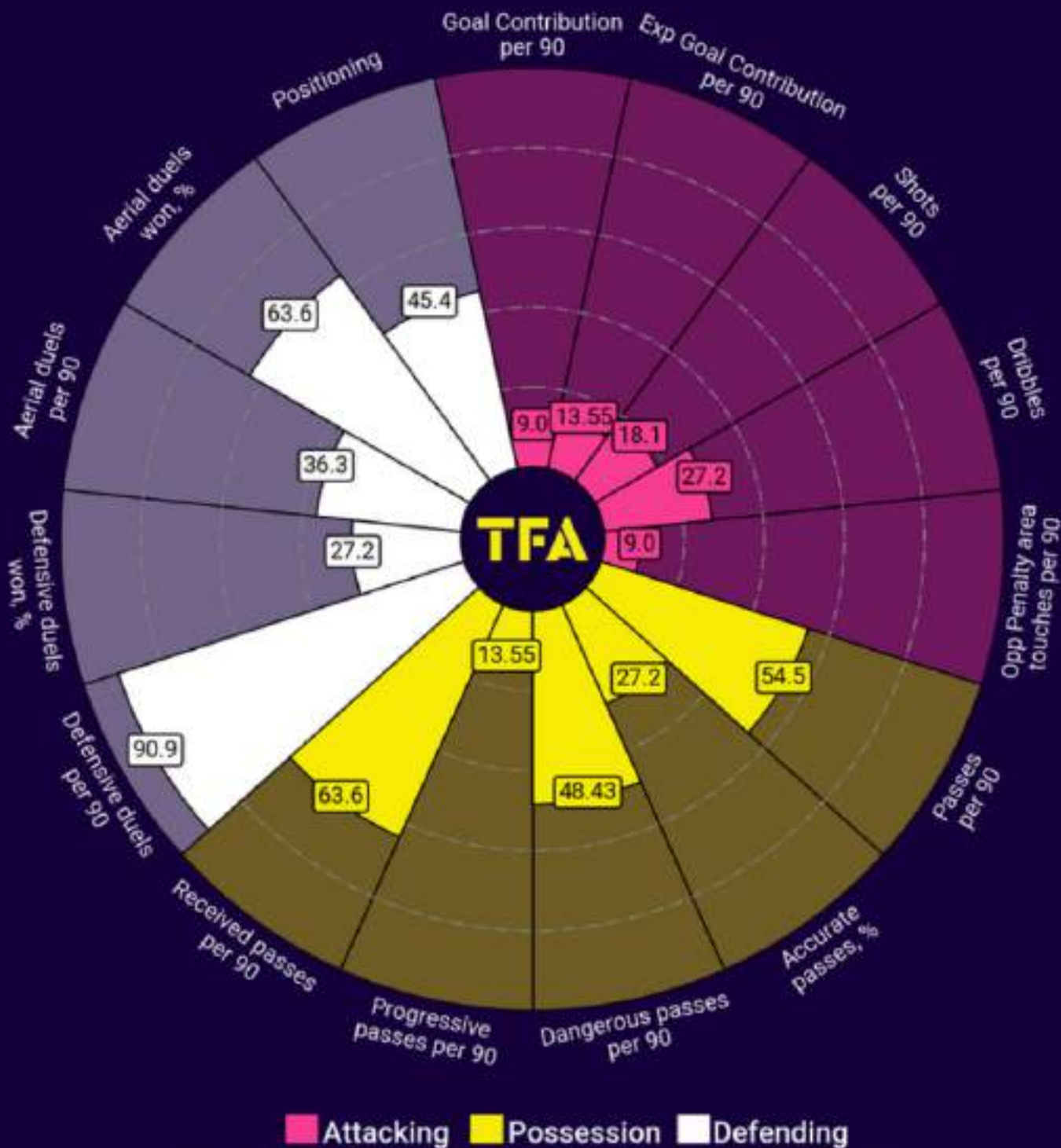

Percentile Rank vs RWBs in Argentina-Liga Profesional-1 | Data from Season 2023

DEFENSIVE PHASE

Giay did manage to get across to opposition runners and showcased a strong pace when having to do so. He did nick the ball away a few times here but never really managed to present himself as a consistent ball winner. Giay's aggressive approach to defend enabled him to quickly cut off passing lanes while he also showcased the strength needed to hold off opponents in the vicinity of his box.

Giay seemed to be more adept at making simpler interceptions and often did well to move around and collect loose balls. He seemed eager to cover for his teammates here as well and often looked to shift into vacant spaces when needed but did show a tendency to get dragged out of position when doing so.

A. GIAY DEFENSIVE TERRITORY

All games from Liga Profesional de Fútbol 2023, Copa Sudamericana 2023, Copa Argentina 2023



A. GIAY HIGH REGAINS

All games from Copa Sudamericana 2023, Liga Profesional de Fútbol 2023, Copa Argentina 2023



ATTACKING PHASE

Giay seemed to be fairly confident on the ball and worked it well when getting pressed. He showcased a progressive passing range and often tried to constantly link up play on the flank with forward passes. He can be a little wasteful with some of these passes when on the move and needs to be more conservative during the side's build up phases.

Giay constantly managed to get forward and even moved into a central role at times. He also showcased good vision to pick out teammates from deep with through balls but does need to be more composed when attempting these passes from within the final third.

He also managed to get into crossing range on the overlap while doing a decent job of staying wide when needed. Despite this, he does need to improve the quality of these efforts as most of them looked rather wayward.

Giay's efforts to dribble were largely lacklustre though as he failed to effectively beat his man during 1v1 situations while also looking weak when having to shield the ball under pressure.

A. GIAY PASS MAP

All games from Copa Sudamericana 2023, Liga Profesional de Fútbol 2023, Copa Argentina 2023

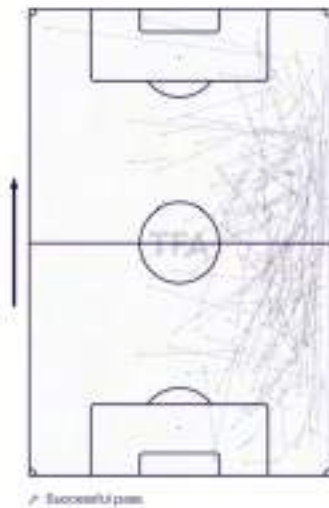

A. GIAY PROGRESSIVE PASSES

All games from Liga Profesional de Fútbol 2023, Copa Sudamericana 2023, Copa Argentina 2023

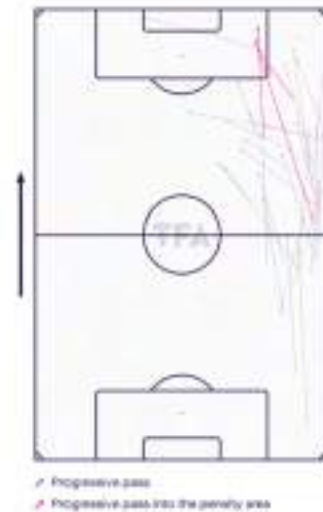

A. GIAY WINGER ACTIONS

All games from Copa Sudamericana 2023, Liga Profesional de Fútbol 2023, Copa Argentina 2023



A. GIAY CROSSING ZONES

All games from Copa Sudamericana 2023, Liga Profesional de Fútbol 2023, Copa Argentina 2023

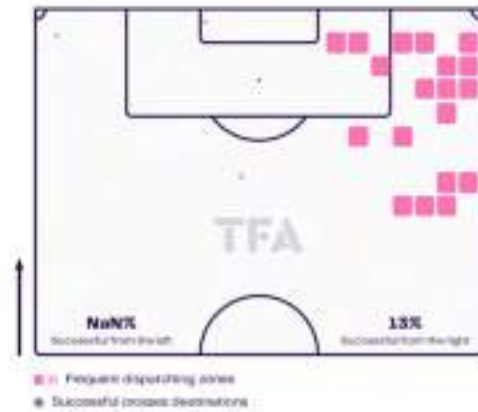

A. GIAY SHOT ASSISTS

All games from Copa Argentina 2023, Copa Sudamericana 2023, Liga Profesional de Fútbol 2023

A. GIAY PENETRATING CARRIES

All games from Copa Argentina 2023, Copa Sudamericana 2023, Liga Profesional de Fútbol 2023

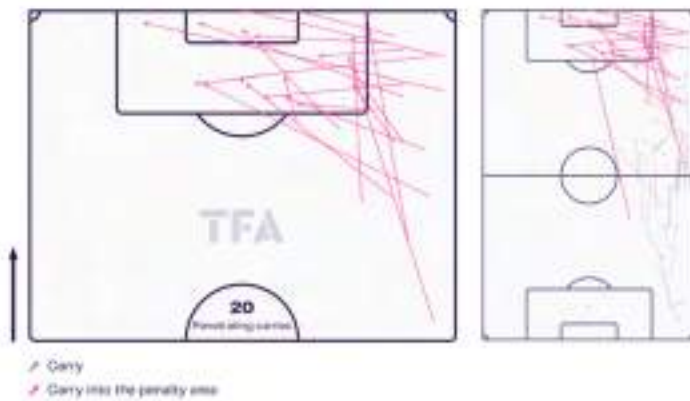

TRANSITIONS

Giay looked active during the side's attacking transitions and seemed eager to dart forward here, often taking up the role of a wing back. He also did well to link up play here while also showcasing the off ball movement required to dart on the return pass as well. Despite this, he does need to play better balls into the opposition area at the end of these transitions as most of his efforts to do so looked weak at the moment.

Giay was very aggressive when it came to the side's defensive transitions and looked to quickly try and push opposition attacks away from his box. He used his pace to track back into strong positions when needed while also doing a decent job of nicking the ball away here. Giay also does well to close down opponents when going into a 1v1 duel and often did well to hold them off.

PHYSICAL PROFILE

Despite standing a solid height of 180cm, Giay did not look to be a dominant figure in the air and lost out to taller players when going into an aerial duel. He lacked the physical profile or aggression to outleap opponents and often found it hard to mark dominant opponents.

Giay has a lean athletic build with good agility and seemed to be quick as well. He also looked capable of holding onto these speeds over longer distances, often doing a decent job of beating his marker in a foot race.

Giay can improve his physicality on the ball as he did show a tendency to get outmuscle when carrying it forward.

A. GIAY BALL PROGRESSION

All games from Liga Profesional de Fútbol 2023, Copa Sudamericana 2023, Copa Argentina 2023



SIMILAR PLAYERS USING XGOLD

xGOLD is our custom-built in-house tool that uses data to match player profiles

Youcef Atal

OGC Nice
87% match

Benjamin Henrichs

RB Leipzig
86% match

Nahuel Molina

Atlético de Madrid
86% match

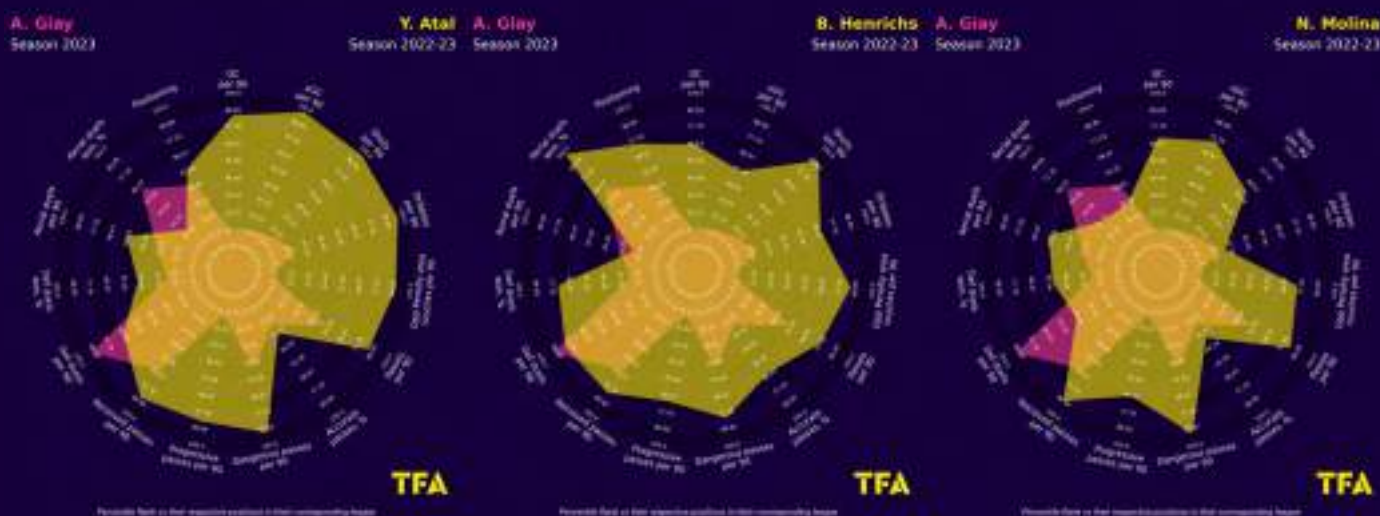

CLUB MATCHING METHODOLOGY

Our custom-built xGOLD tool has the ability to match players to clubs from a data-driven tactical fit perspective - we then take the initial shortlist and go into further scout-led filtering, considering the key points below.

A) Playing Style

Assessing teams by their playing style and finding a suitable match for Giay: Teams who average a low number of defensive duels per 90 and a high passing volume to accommodate his build up play.

B) Leagues

We are looking at options from German Bundesliga, Italy Serie A, Spanish La Liga and Belgian Pro League.

C) Statistics

Players who are statistically similar to Giay and whose contracts are ending and he could replace.

Belgian Pro League

Gent

- They average around 462.7 passes per 90 and are a team who looks to build up play from deep.
- They only average around 68.7 defensive duels per 90 and need a more combative figure in the side.
- Teamfit match of 72%

Club Brugge

- They average around 457.42 passes per 90 and are a team who looks to build up play from deep.
- They only average around 61.45 defensive duels per 90 and need a more combative figure in the side.
- Teamfit match of 75%

Antwerp

- They average around 441.6 passes per 90 and are a team who looks to build up play from deep.
- They only average around 66.37 defensive duels per 90 and need a more combative figure in the side.
- Teamfit match of 80%

Italy Serie A

Torino

- They average around 424.86 passes per 90 and are a team who looks to build up play from deep.
- They only average around 57.87 defensive duels per 90 and need a more combative figure in the side.
- Teamfit match of 76%

Bologna

- They average around 446.97 passes per 90 and are a team who looks to retain possession at the back when on the back foot.
- They only average around 66.86 defensive duels per 90 and need a more combative figure in the side.
- Teamfit match of 73%

AS Monza

- They average around 446.12 passes per 90 and are a team who looks to build up play from deep.
- They only average around 65.68 defensive duels per 90 and need a more combative figure in the side.

Spanish La Liga

Sevilla

- They average around 412.62 passes per 90 and are a team who looks to build up play from deep.
- They only average around 57.93 defensive duels per 90 and need a more combative figure in the side.
- Can be a solid back up to an ageing Jesus Navas.

Real Sociedad

- They average around 405.06 passes per 90 and are a team who looks to build up play from deep.
- They only average around 67.56 defensive duels per 90 and need a more combative figure in the side.
- Can be a future upgrade on Aritz Elustondo.
- Teamfit match of 75%

Celta de Vigo

- They average around 399.97 passes per 90 and are a team who looks to retain possession at the back when on the back foot.
- They only average around 63.02 defensive duels per 90 and need a more combative figure in the side.
- Can be a future upgrade on Hugo Mallo.
- Teamfit match of 76%

German Bundesliga

Eintracht Frankfurt

- They average around 438.08 passes per 90 and are a team who looks to build up play from deep.
- They only average around 63.78 defensive duels per 90 and need a more combative figure in the side.
- Can offer more defensive stability on the flank when playing in a back three.

Bayer Leverkusen

- They average around 446.22 passes per 90 and are a team who looks to build up play from deep.
- They only average around 54.47 defensive duels per 90 and need a more combative figure in the side.
- Jeremie Frimpong's future is uncertain at the moment.
- Teamfit match of 74%

Borussia M'gladbach

- They average around 459.17 passes per 90 and are a team who looks to build up play from deep.
- They only average around 52.28 defensive duels per 90 and need a more combative figure in the side.
- Can provide competition to Joe Scally on the right flank.
- Teamfit match of 77%



JUVENTUS NEXT GEN



FRENCH

FÉLIX NZOUANGO

JUNE 2023

SCOUT REPORT



Félix Nzouango Juventus Next Gen

Category	Description	Points
International Appearances	No data	0
Domestic Minutes	Band 6: 0%	0
Continental Minutes	No data	0
League Position	Juventus Next Gen: Serie C - #20	0
Continental Progression	No data	0
League Quality	Serie C	2
Total	Ineligible	2

This calculation is based on rules agreed by the FA and the Home Office for players to play in England. There will be edge cases and different interpretations. Our Governing Body Endorsement (GBE) status tool should be used as a guide to assess the likelihood of a player meeting the criteria, rather than a definitive assessment. GBE criteria are regularly reviewed by the FA and Home Office. Any changes will be incorporated into our calculations when they are announced.

NI: Our calculations don't currently take into account injury data or, for players under 21, any additional points from the youth criteria. There are variations to the GBE criteria for players to play in Scotland and details can be found on the Scottish FA website.

TFA

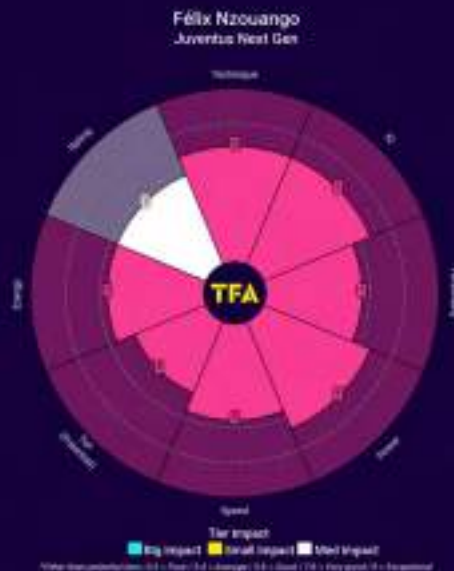

Felix Nzouango is a young center back who can play as an RCB or sweeper in a back 3. He is composed on the ball and likes to patiently build up the play through the press, he can pass and control the ball with both feet but needs to play more passes through lines and be more accurate with his long passes. He is not the most dominant in duels, aerially or on the ground. He lacks agility and can be vulnerable against quick forwards but does well when going shoulder-to-shoulder. He does not win enough headers for his height and size either. His positional sense is excellent for a young defender. He always looks to recover and get back into central areas to prevent gaps in the defence showing a good understanding of defensive fundamentals.

T - Technique I - IQ (football intelligence) P - Personality P - Power S - Speed T - Tier (potential Tier - see explainer) E - Energy
R - Rating (Big, Medium, Small) if he moved to that Tier today

Score explanations (other than potential tiers): 0-2 = poor 3-4 = average 5-6 = good 7-8 = very good 9 = exceptional

PLAYER PROFILE

Félix Nzouango is a 20-year-old French footballer who plays as a defender for Juventus Next Gen in Serie C -A, the third tier of Italian football..

He was predominantly right footed but also looked capable of using his left when needed. He is a current French U20 international as well.

Nzouango has a current market value of €800,000.

PLAYER HISTORY

Nzouango came through the ranks of the Amiens SC academy and moved to the Juventus set up during the 20/21 season. He then rose up to settle in with the reserve side during the 22/23 campaign.

F. NZOUANGO HEATMAP

All games from Serie C 2022/2023

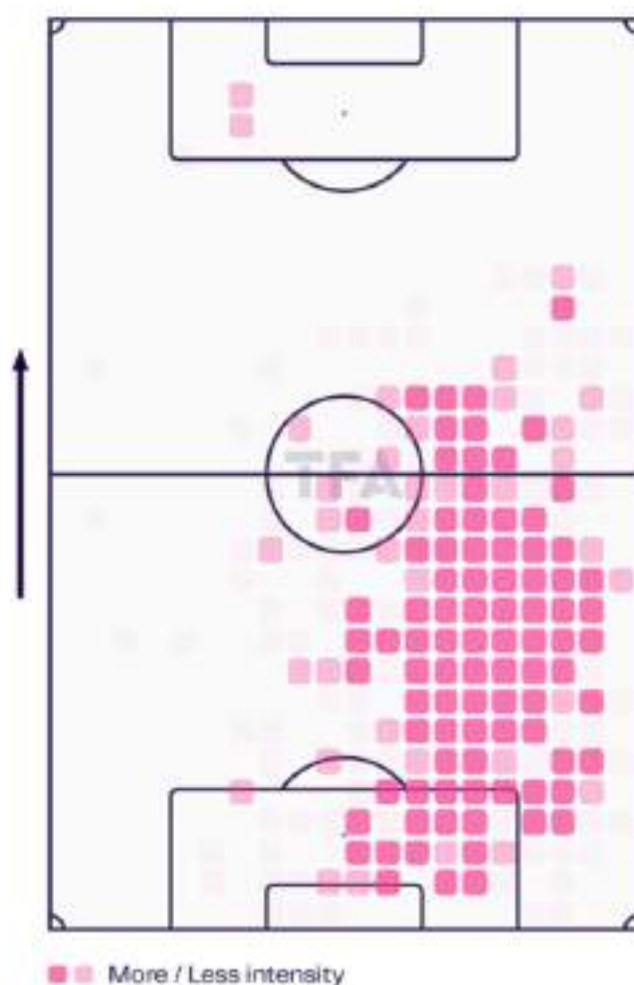

F. Nzouango | RCB | 630 minutes played
 Juventus Next Gen | 20-years-old | Season 2022-23

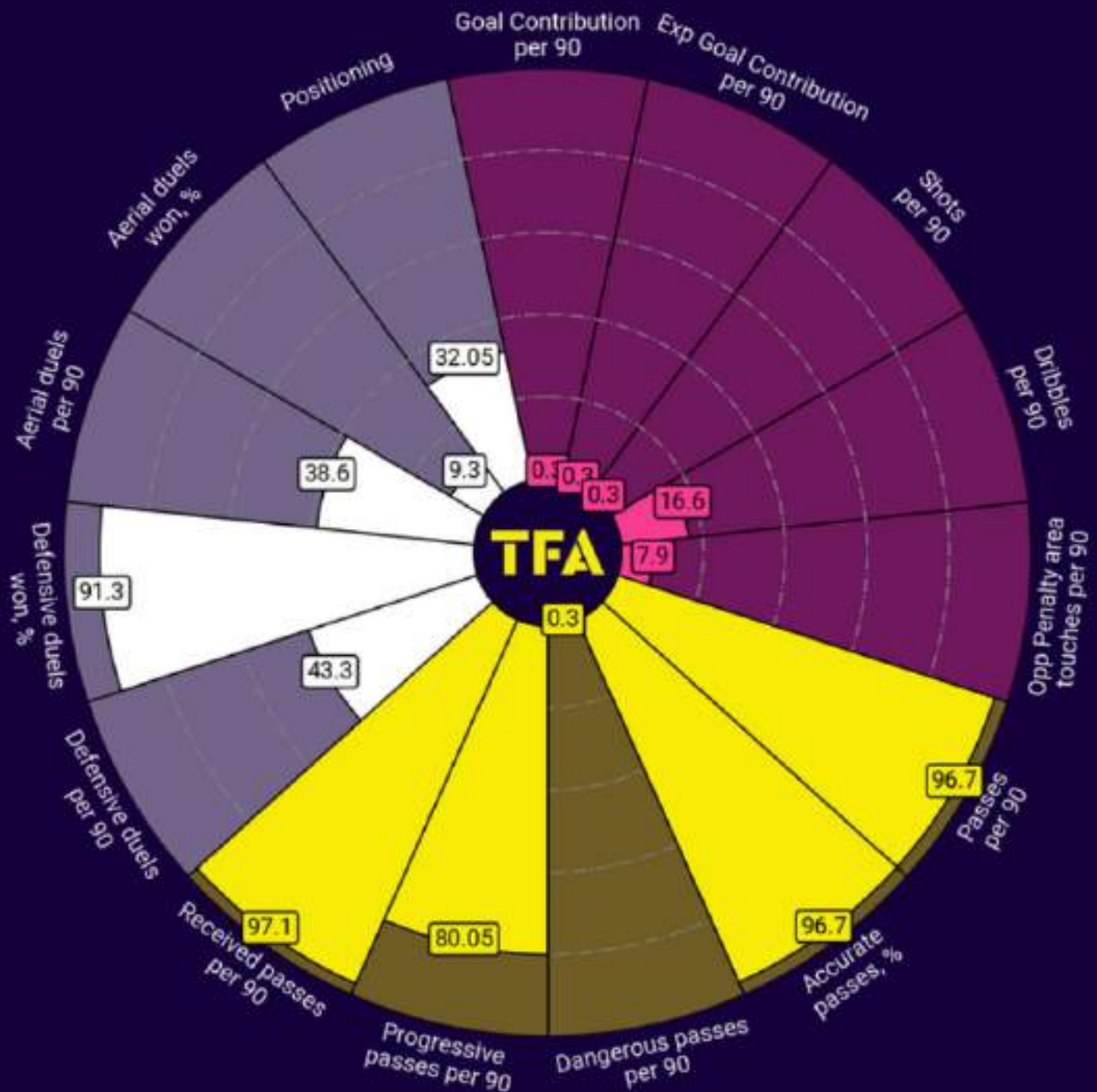

Attacking Possession Defending

Percentile Rank vs RCBs in Italy-Serie C-3 | Data from Season 2022-23

DEFENSIVE PHASE

Nzouango is a decent defender 1v1 but not the most reliable. He likes to close down quickly but does not get too tight or commit himself, and keeps good distance from his man. He does not put in very hard or rash tackles and generally looks to nick the ball or use his body. However, he is not agile and struggles when faced against quick wingers. He is unable to react quickly enough when they look to accelerate away from him and is often beaten by quick changes of pace.

Nzouango shows great positional awareness whether he is playing as an LCB or sweeper in a back 3. He is always looking to tuck in, get into more central positions and prevent any gaps in the defense. He understands when to step out and get tight but is quick enough to get back if beaten. He shows good understanding with his fellow defenders to cover for them and vice versa. Because of his positional sense, he makes a lot of interceptions from crosses and through balls in the defensive 3rd.

F. NZOUANGO DEFENSIVE TERRITORY

All games from Serie C 2022/2023

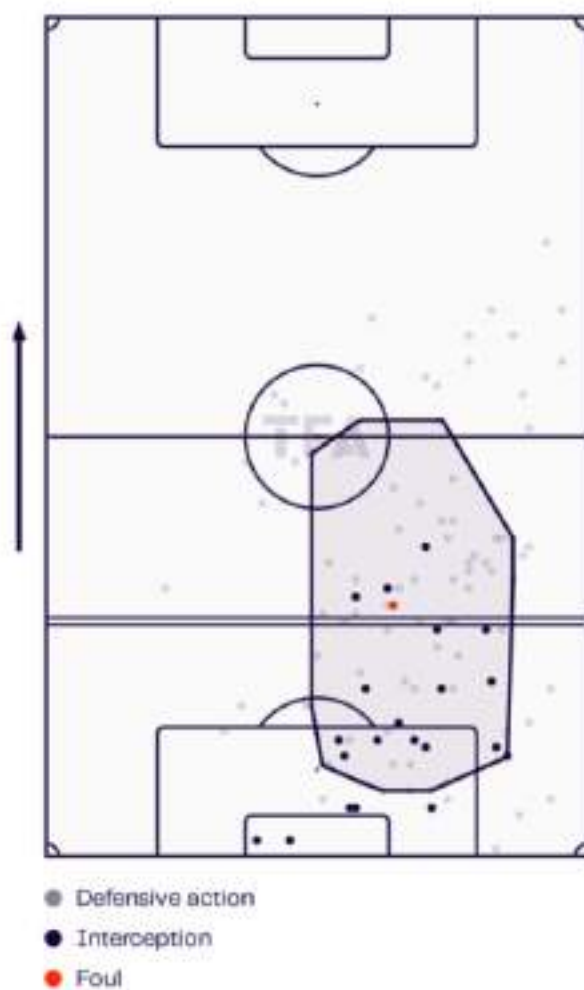

ATTACKING PHASE

Nzouango is very composed on the ball and looks to play his way out of the press. Even when closed down, he rarely panics and clears long and tries to pass his way out with short lateral passes or long balls into his forwards. He can receive and pass with both feet although his preferred foot seems to be left. He generally plays short lateral passes or out wide but has the vision to play passes through lines when given space.

Nzouango is not the quickest and rarely looks to stride forward with the ball. He generally looks to release early and will not take on his man 1v1 when charged down. He makes good passing angles by dropping deep and coming wide, all the way to the left touchline at times when playing as an LCB in a back 3.

Despite his height and size, Nzouango is not dominant in the air and should do much better aerially from set pieces in the opposition half. He is rarely seen getting first contact or directing headers goal wards from corners and freekicks despite being one of his team's targets.

F. NZOANGO PASS MAP F. NZOANGO PROGRESSIVE PASSES

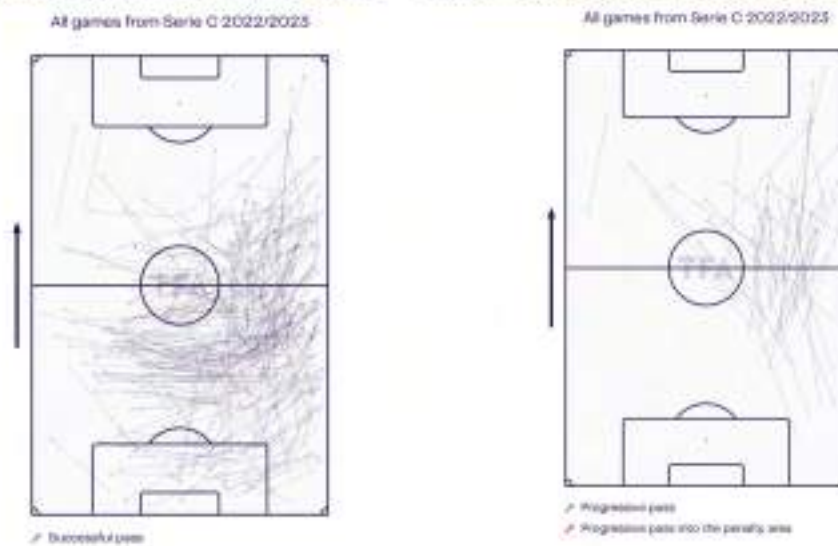

F. NZOANGO PENETRATING CARRIES



TRANSITIONS

Nzouango is not the most effective or adventurous in offensive transitions. He secures the first pass after a turnover and generally looks to play a short lateral or backward pass to recycle possession instead of playing forwards and trying to break on the counter.

Nzouango is effective in defensive transition, relying on his positional sense and long strides to defend effectively. As soon as there is a turnover, he immediately looks to run back into central areas of the defense to negate any danger. He shows good pace over distance, is able to track runners from deep and is also able to intercept a lot of through balls because of his awareness.

F. NZOUANGO BALL PROGRESSION



PHYSICAL PROFILE

Although Nzouango stands at 188cm tall, he is not dominant in the air and needs to improve aerially. He does not often outjump his opposition forwards and can also be eased out of the flight of the ball occasionally. Even when he did win his headers, he did not do so very convincingly and get great distance and direction on them.

Nzouango possessed a lean build and seemed to cover a decent amount of ground in the games watched. He does lack a bit of agility on the turn and was far from being the quickest player on the pitch.

Nzouango showcased good body strength when going into a duel and but still needs to improve his balance here.

SIMILAR PLAYERS USING XGOLD

xGOLD is our custom-built in-house tool that uses data to match player profiles

Rúben Dias

Manchester City F.C.
85% match

Victor Lindelöf

Manchester United F.C.
82% match

Levi Colwill

Brighton & Hove Albion F.C.
80% match

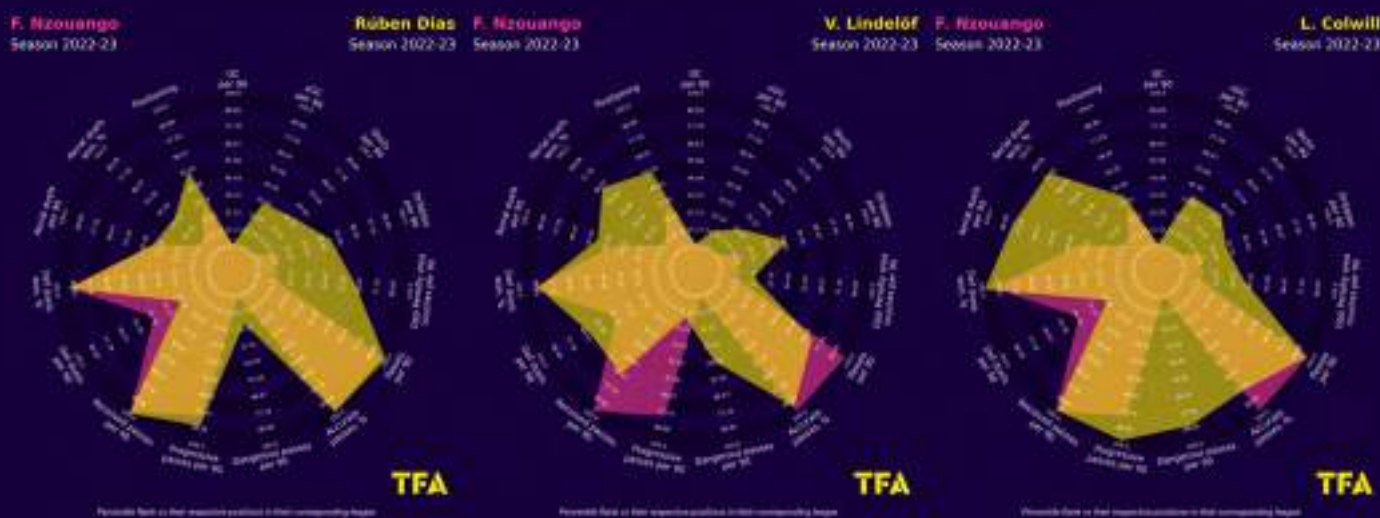

CLUB MATCHING METHODOLOGY

Our custom-built xGOLD tool has the ability to match players to clubs from a data-driven tactical fit perspective - we then take the initial shortlist and go into further scout-led filtering, considering the key points below.

A) Playing Style

Assessing teams by their playing style and finding a suitable match for Nzonzo:
Teams who average a low number of progressive passes per 90 and a low defensive duel success rate.

B) Leagues

We are looking at options from German 2. Bundesliga, Scottish Premiership, USA MLS and Austrian Bundesliga.

C) Statistics

Players who are statistically similar to Nzonzo and whose contracts are ending and he could replace.

German 2. Bundesliga

Hamburger SV

- They average around 62.54 progressive passes per 90 and need a better passer from a deeper role.
- The side's defensive duel success rate of 56.95% needs improvement.
- Mario Vuskovic needs a solid back given his doping ban till the end of 2024.
- Teamfit match of 61%

Hannover 96

- They average around 63.27 progressive passes per 90 and need a better passer from a deeper role.
- The side's defensive duel success rate of 57.9% needs improvement.
- Bright Arrey-Mbi is expected to return to Bayern at the end of this campaign.
- Teamfit match of 67%

Fortuna Düsseldorf

- They average around 65.64 progressive passes per 90 and need a better passer from a deeper role.
- The side's defensive duel success rate of 55.52% needs improvement.
- Andre Hoffmann is ageing and the side needs more tactical defenders in their push for Bundesliga.
- Teamfit match of 67%

Scottish Premiership

Aberdeen

- They average around 58.04 progressive passes per 90 and need a better passer from a deeper role.
- The side's defensive duel success rate of 60.6% needs improvement.
- The side only has 3 designated CBs at the moment and needs better back up.
- Teamfit match of 57%

Ross County

- They average around 63.01 progressive passes per 90 and need a better passer from a deeper role.
- The side's defensive duel success rate of 61% needs improvement.
- Dylan Smith at 16 years needs more time and needs a dependable back until he can develop.

Motherwell

- They average around 64.97 progressive passes per 90 and need a better passer from a deeper role.
- The side's defensive duel success rate of 60.2% needs improvement.
- Their CBs at the moment all have a similar playing style and Nzouango could offer something different.
- Teamfit match of 56%

USA MLS

New York RB

- They average around 58.42 progressive passes per 90 and need a better passer from a deeper role.
- The side's defensive duel success rate of 62.60% needs improvement.
- Would be an upgrade on their existing defensive partnership.

Austin FC

- They average around 60.46 progressive passes per 90 and need a better passer from a deeper role.
- The side's defensive duel success rate of 58.2% needs improvement.
- Leo Väisänen is out with a ruptured ACL and needs back up.
- Teamfit match of 63%

Toronto FC

- They average around 57.63 progressive passes per 90 and need a better passer from a deeper role.
- The side's defensive duel success rate of 62.3% needs improvement.
- Matt Hedges is on the wrong side of 30 and Shane O'Neill is out injured.
- Teamfit match of 65%

Austrian Bundesliga

Sturm Graz

- They average around 69.07 progressive passes per 90 and need a better passer from a deeper role.
- The side's defensive duel success rate of 66.63% needs improvement.
- Paul Komposch is leaving on a free and Alexandar Borkovic is out with an injury.

Rapid Wien

- They average around 71.47 progressive passes per 90 and need a better passer from a deeper role.
- The side's defensive duel success rate of 60.29% needs improvement.
- Leopold Querfeld and Maximilian Hofmann are out for an indefinite period while Kevin Wimmer has left on a free, leaving the backline hollow.
- Teamfit match of 70%

LASK

- They average around 72.20 progressive passes per 90 and need a better passer from a deeper role.
- The side's defensive duel success rate of 64.07% needs improvement.
- Yannis Letard and Jan Boller have suffered ACL injuries while Philipp Zierys is entering his 30s.
- Teamfit match of 68%



SEONGNAM



SOUTH KOREA

JI-SOO KIM

JUNE 2023

SCOUT REPORT



Ji-soo Kim Seongnam FC

Category	Description	Points
International Appearances	No data	0
Domestic Minutes	Band 6: 47%	0
Continental Minutes	No data	0
League Position	Seongnam: Korea Republic K League 1 0#12	
Continental Progression	No data	0
League Quality	K League 2	2
Total	Ineligible	2

This calculation is based on rules agreed by the FA and the Home Office for players to play in England. There will be edge cases and different interpretations. Our Governing Body Endorsement (GBE) status tool should be used as a guide to assess the likelihood of a player meeting the criteria, rather than a definitive assessment. GBE criteria are regularly reviewed by the FA and Home Office. Any changes will be incorporated into our calculations when they are announced.

NB: Our calculations don't currently take into account injury data or, for players under 21, any additional points from the youth criteria. There are variations to the GBE criteria for players to play in Scotland and details can be found on the Scottish FA website.

TFA



Ji Soo Kim is an 18-year-old centre-back who slots in on the left side of a 3-man defence but can also play in a back 4. He is quite confident on the ball and looks secure with his ground passes. He is willing to play long and diagonal passes but needs to be more consistent with his execution. Defensively, his positioning and reading of the game look astute. He seems to play with maturity beyond his age as he hardly made any sort of hasty decisions. He prefers to hold his ground instead of lunging into tackles in 1 v 1 situations and tries to close down shooting/passing angles open for his man. He needs to be quick at changing his direction when coming up against pacey opponents. Aerially he is decent but needs to be more dominant considering his tall frame.

At 18, he looks like an interesting prospect with a high resale value and looks set for a future in Europe's top leagues.

T = Technique I = IQ (football intelligence) P = Personality P = Power S = Speed T = Tier (potential Tier - see explainer) E = Energy
R = Rating (Big, Medium, Small) if he moved to that Tier today

Score explanations (other than potential tiers) 0-2 = poor 3-4 = average 5-6 = good 7-8 = very good 9 = exceptional

PLAYER PROFILE

Ji-soo Kim is an 18-year-old left-centre-back who plays for Seongnam FC in the Korea First Tier.

He is predominantly left-footed but looks comfortable using his right foot as well. He plays on the left side and can slot in a 3-man or a 4-man defence.

He has a current market value of €350,000

PLAYER HISTORY

Kim is a product of Donggok Academy and moved to Seongnam which is where he made his progress. He is currently with their first team.

JI-SOO KIM HEATMAP

All games from K League 1 2022

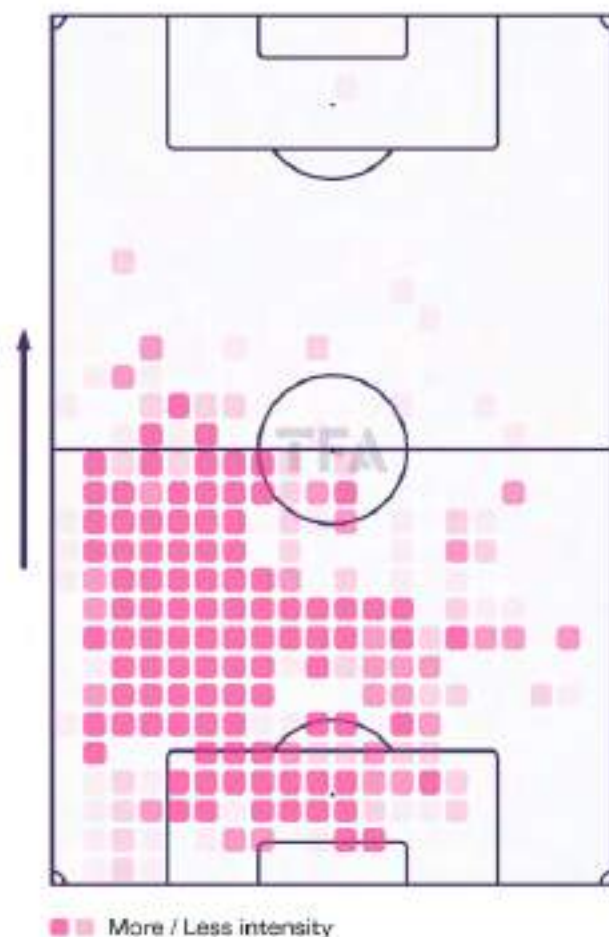

Ji-Soo Kim | LCB | 1660 minutes played
Seongnam | 18-years-old | Season 2022-23

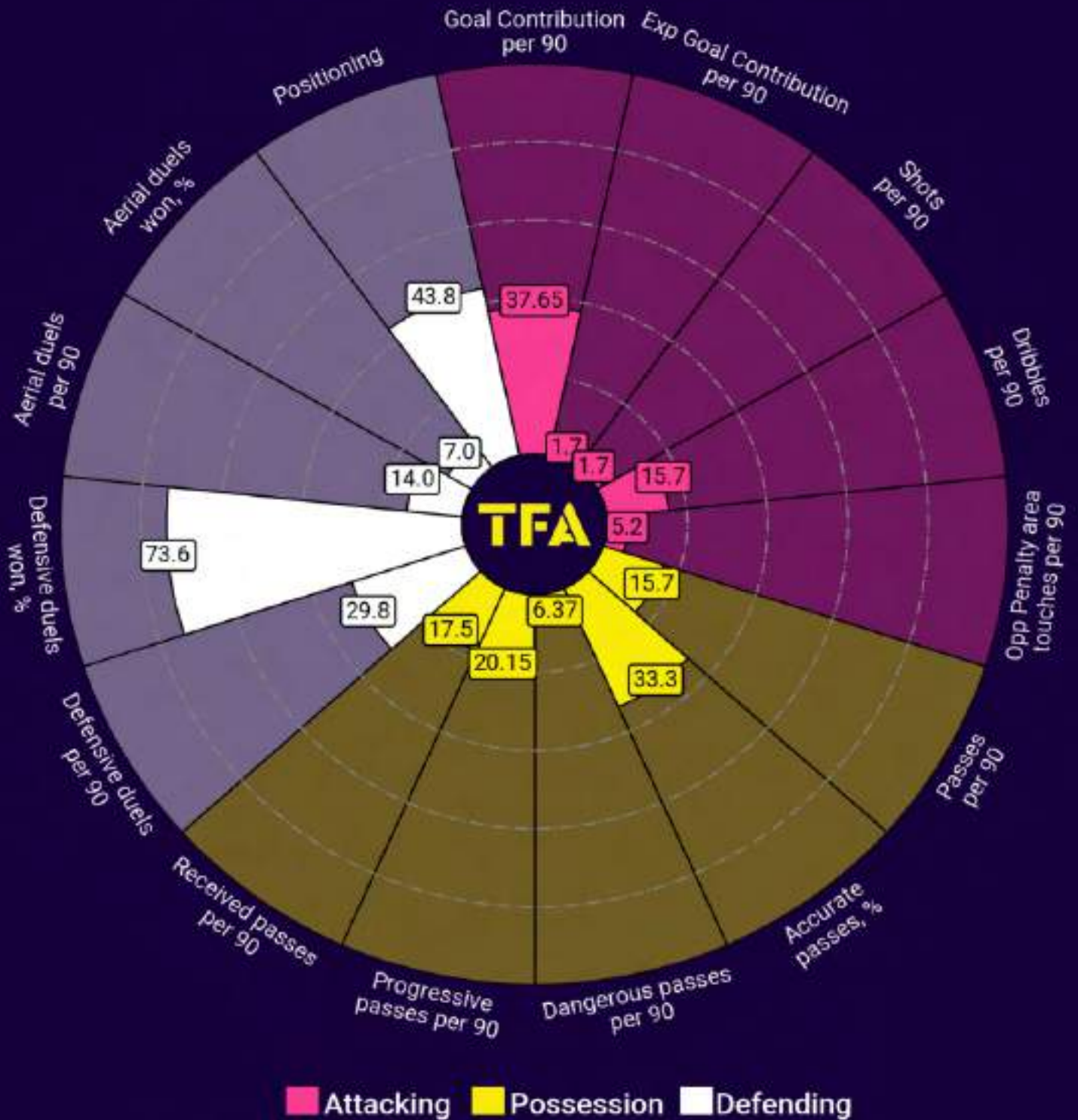

Percentile Rank vs LCBs in Korea-K League 1-1 | Data from Season 2022-23

DEFENSIVE PHASE

Kim is seen constantly checking his shoulders to monitor the runs of his opponent. He doesn't look the quickest but has long strides which enables him to get to the ball ahead of his opponent when a long ball is played forward. He has a good read of the game and doesn't struggle to play in a high defensive line. He has a long reach which allows him to nick the ball away from his man. In a low block, he tends to tuck in narrow.

With his man running at him, he prefers to hold his ground and cover the passing or shooting angle instead of lunging into a tackle. He does use his tall frame to either cover the inside or the outside. In the wide areas, he is generally quick to close down and tries to push his opponent away from the goal by being physical.

Kim wins his fair share of headers but is expected to dominate aerially considering his imposing frame. He does struggle against stronger opponents where he doesn't jump above them to win his headers which is something he will improve with age and experience. Albeit, he does get good distance on his headed clearances.

JI-SOO KIM DEFENSIVE TERRITORY

All games from K League 1 2022

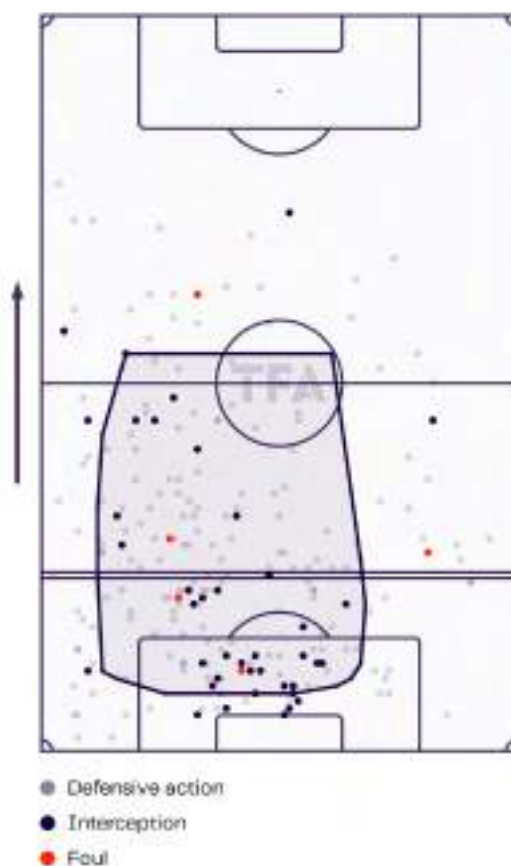

ATTACKING PHASE

Kim generally plays on the left side of a back 3 and shows good composure on the ball. During the build-up phase, he tends to move wide to receive the ball. His first touch is neat and often finds himself with time on the ball to assess his passing options. His lateral passes are secure and can also be seen attempting forward/long passes. His forward passes along the ground were generally precise but when he plays it aerially, he needs to be more consistent with his execution.

Kim provides good passing options for his defensive partners or midfielders. He starts in a low block and then progresses forward. He doesn't look like a ball carrier, nevertheless, he is brave getting on the ball in tight spaces and generally picks the right pass. He doesn't look hurried under pressure and is able to play through it.

JI-SOO KIM PASS MAP

All games from K League 1 2022

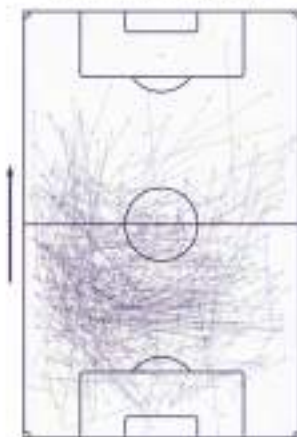

✓ Successful pass

JI-SOO KIM PROGRESSIVE PASSES

All games from K League 1 2022

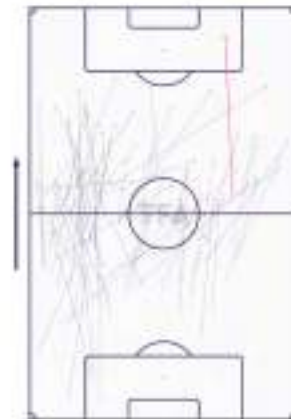

✓ Progressive pass
✓ Progressive pass into the penalty area

JI-SOO KIM PENETRATING CARRIES

All games from K League 2 2023, K League 1 2022



✓ Carry
✓ Carry into the penalty area

TRANSITIONS

Kim is not the most influential during the attacking transitions. He predominantly indulges in the slow build-up play and is seen playing a lot of short and lateral passes. With time on the ball, he also looks up to spot the runs of his opponent. He does well to play long and diagonal passes but with better execution, he will be able to make a significant impact.

Kim in defensive transitions looks like a reliable player. He is quick to drop back when a forward pass is played and often intercepts it by getting to it ahead of the ball. In 1 v 1 duels, he tends to rely on his tall frame and long reach to fend off his opponent and nick the ball away from them. He does struggle against opponents who run at pace but apart from which he looks pretty solid.

JI-SOO KIM BALL PROGRESSION

All games from K League 1 2022



PHYSICAL PROFILE

Kim stands at 192cm, has an athletic muscular physique and seems to win his fair share of headers. This being said, he doesn't dominate in the air as such. He is strong physically and rarely beaten shoulder to shoulder.

Despite his frame, he is moderately agile and has a decent pace over short and long distances, especially once he gets into his stride.

He is a two-footed player.

SIMILAR PLAYERS USING XGOLD

xGOLD is our custom-built in-house tool that uses data to match player profiles

W. Faes

Leicester
76% match

F. Tomori

Milan
70% match

M. Guéhi

Crystal Palace
70% match



CLUB MATCHING METHODOLOGY

Our custom-built xGOLD tool has the ability to match players to clubs from a data-driven tactical fit perspective - we then take the initial shortlist and go into further scout-led filtering, considering the key points below.

A) Playing Style

Assessing teams by their playing style and finding a suitable match for Kim: Teams who average a slightly low defensive duel success rate. He could potentially be a solid backup option for teams in need of a young defender.

B) Leagues

We are looking at options for teams in the top tiers of Netherlands, Portugal and Belgium

C) Statistics

Players statistically similar to Ji-soo Kim and whose contracts are ending and he could replace.

Netherlands Eredivisie

FC Utrecht

- They average a 60.6% defensive duel success rate with the league average at 62.11%
- 3 of their current CBs will be a free agent post-summer

Vitesse

- They average a 61.6% defensive duel success rate with the league average at 62.11%
- With 3 of their CBs leaving on a free this summer, he could be a quality addition at the back

Heerenveen

- They average a 61.3% defensive duel success rate with the league average at 62.11%
- Lack of cover at the back with 2 experienced CBs leaving on a free transfer

Portugal Primeira Liga

FC Porto

- They average a 57.8% defensive duel success rate with the league average at 58.59%
- He could be a valuable back up considering Pepe and Marcano are past their prime

SL Benfica

- They average a 62% defensive duel success rate with the league average at 58.59%
- He could be a valuable back up considering the possibility for António Silva and Morato to move elsewhere
- Otamendi approaching his later stages

SC Braga

- They average a 60.3% defensive duel success rate with the league average at 58.59%
- With one of their four CBs departing after their loan spell, he could provi

Belgium Jupiler Pro League

Royal Antwerp FC

- They average a 61.3% defensive duel success rate with the league average at 62.47%
- With William Pacho leaving, they seem to lack cover at the back

RSC Anderlecht

- They average a 62.4% defensive duel success rate with the league average at 62.47%
- He could be a solid back up for someone like Vertongen at 36

KAA Gent

- They average a 63.2% defensive duel success rate with the league average at 62.47%
- With Kamil Piatkowski leaving, he could compete for a first team spot



GANGWON FC



SCOUT REPORT

SOUTH KOREA

SEUNG-WON LEE

JUNE 2023



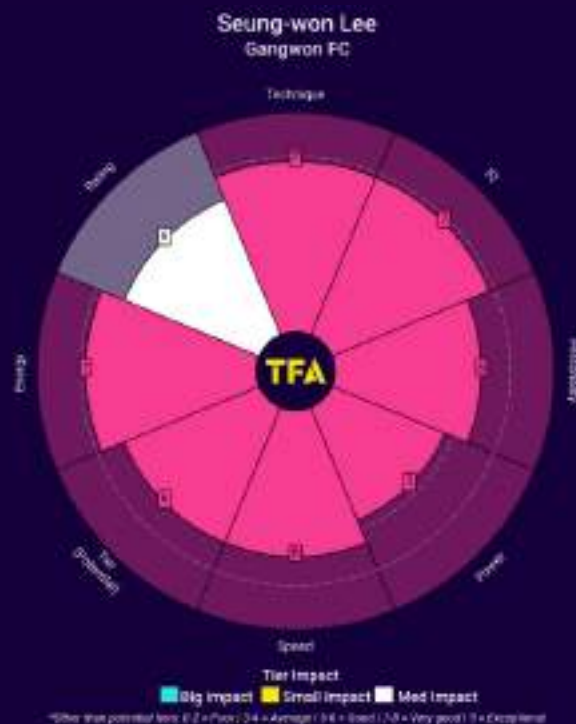

Seung-won Lee is a 20-year-old midfielder who is highly mobile and looks like a box-to-box. Good on the ball and comfortable playing with minimal touches. Keeps himself on the move to create passing options and also gets into the attacking third regularly. He can be progressive with his passing and also poses a goal threat with his forward runs. He lacks the strength however to withstand challenges from his opponent.

Defensively, he shows a decent work ethic as he indicates his willingness to press higher up the pitch and also tracks back to help out his backline when needed. However, at times he did look a bit slow to recover in transitions indicating his lack of commitment. He needs to improve his physique to be able to sustain at a higher level.

T - Technique I - IQ (football intelligence) P - Personality P - Power S - Speed T - Tier (potential Tier - see explainer) E - Energy
 R - Rating (Big, Medium, Small) if he moved to that Tier today

Score explanations (other than potential tiers): 0-2 - poor 3-4 - average 5-6 - good 7-8 - very good 9 - exceptional

PLAYER PROFILE

Seung-won Lee is a 20-year-old who plays as a centre-midfielder for Gangwon II in the Korea Fourth Tier.

He is a right-footed player who can use his left foot when needed. He operates as a box-to-box midfielder and can play in a double pivot or in a slightly advanced role.

He has a market value of €50,000.

PLAYER HISTORY

Lee moved to Gangwon in January 2023 and has been a part of their B team. He is slowly being integrated into their first team.

SEUNG-WON LEE HEATMAP

All games from K4 League 2023

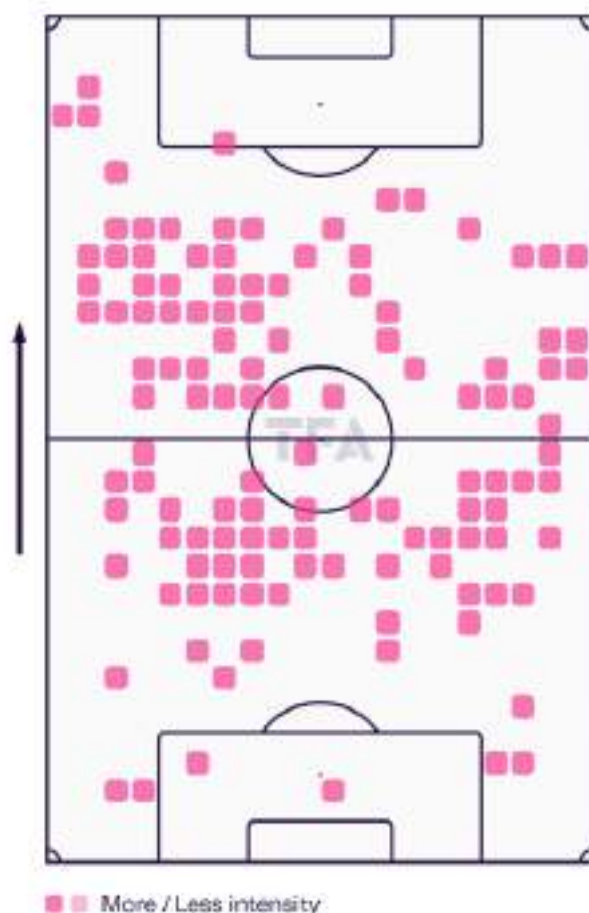

DEFENSIVE PHASE

Lee is quick to close down the opposition in the attacking or the midfield and reacts well to turnovers. He is quite mobile as well which allowed him to cover several positions in the pitch. He shows good intensity and aggression without the ball. He looks to close down the opposition higher up the pitch wherein, he understands pressing triggers and supports his teammate when they look to press high. He is quick and mobile which allows him to operate in a team which adopts a high-intensity style of play.

He is a little weak/sloppy in duels and doesn't seem to win a large volume of his duels. He also looked a bit slow and lacked commitment on a few occasions while trying to track back. With a small frame, he lacks a competent presence while indulging in aerial duels.

SEUNG-WON LEE DEFENSIVE TERRITORY

All games from K4 League 2023

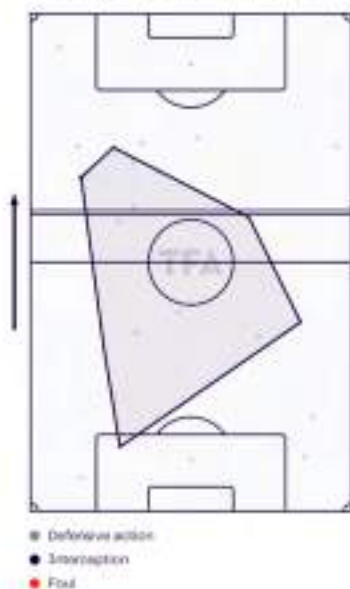

SEUNG-WON LEE HIGH REGAINS

All games from K4 League 2023



ATTACKING PHASE

He looks like a technically astute midfielder who is well aware of the space around him. He is quite mobile and generally gets into the pockets of spaces in the middle or the attacking half. His first touch is quite neat and relies on his deft touches to operate within tight spaces. Keeps himself constantly on the move upon playing a pass to be able to receive the ball back. Lacks the strength to withstand challenges from his opponent.

He shows a decent passing range. He is comfortable playing short and simple passes, particularly in tight spaces. Looks to play with minimal touches in order to link up with his teammates. He looks to be progressive with his passing as well and did attempt aerial passes time and again. Has the vision to switch the play to either flank with diagonal passes. Despite being a right-footed player, he could use his left foot when needed to play short passes.

Excellent mobility for a midfielder indicating attributes of a box-to-box type. He is skilful on the ball and has the ability to drive forward when there is space on offer particularly in transitions. Shows decent goalscoring intent with his runs into the box and efforts from range but has scope for improvement.

SEUNG-WON LEE PASS MAP

All games from K4 League 2023



✓ Successful pass

SEUNG-WON LEE PROGRESSIVE PASSES

All games from K4 League 2023



✓ Progressive pass
✓ Progressive pass into the penalty area

SEUNG-WON LEE SHOT ASSISTS

All games from K4 League 2023



SEUNG-WON LEE SHOTS

All games from K4 League 2023



SEUNG-WON LEE PENETRATING CARRIES

All games from K4 League 2023



TRANSITIONS

Lee acts as the link between the defence and the attack. He makes himself available to receive the ball and quickly moves it forward to assist the attacking transitions. He can be progressive with his passing and also drives forward when there is space available for him to do so. His mobile nature allows him to occupy several positions in the middle and also move further up the pitch when needed.

Lee shows prompt reactions and good aggression with his counter-press. His recovery intent is quite promising and has the willingness to drop back but can be a little slow to track back and help out his backline in transitions.

SEUNG-WON LEE BALL PROGRESSION

All games from K4 League 2023



PHYSICAL PROFILE

Lee stands at 174cm and has a lean physique. He is a little weak in defensive duels and also could be outmuscled when he was on the ball. Lacks a competent aerial presence as well.

He is extremely mobile and covers good ground. He has a sufficient pace and seems to work hard on and off the ball.

He is a right-footed player.

CLUB MATCHING METHODOLOGY

Our custom-built xGOLD tool has the ability to match players to clubs from a data-driven tactical fit perspective - we then take the initial shortlist and go into further scout-led filtering, considering the key points below.

A) Playing Style

Assessing teams by their playing style and finding a suitable match for Lee: Teams who tend to dominate possession in their respective leagues and also those who are looking for a progressive passer.

B) Leagues

We are looking at options for teams in the third tier of Germany and the second tiers of the Netherlands and Portugal

C) Statistics

Players statistically similar to Seung-won Lee and whose contracts are ending and he could replace.

Germany 3 Liga

Verl

- They have an average possession of 56.4% this season
- They attempt 66.37 progressive passes per 90 whereas the league average is 71.31
- His versatility would work well considering they play with 8 as well as a 10

Osnabrück

- They have an average possession of 53% this season
- They attempt 69.92 progressive passes per 90 whereas the league average is 71.31
- Reliable backup for Robert Tesche (36) also capable of pushing for a first team slot

Dynamo Dresden

- They have an average possession of 53.1% this season
- They attempt 70.37 progressive passes per 90 whereas the league average is 71.31
- 3 of their current midfield options are leaving on a free transfer and also his versatility could be significant

Netherlands Eerste Divisie

Roda JC

- They have an average possession of 53.4% this season
- They attempt 67.15 progressive passes per 90 whereas the league average is 72.63
- Lack of depth in the midfield and Niek Vossebelt is 31

NAC Breda

- They have an average possession of 50.5% this season
- They attempt 72.57 progressive passes per 90 whereas the league average is 72.63
- With 3 of their creative midfielders leaving this summer, his progressive mindset could be valuable

Utrecht II

- They have an average possession of 50% this season
- They attempt 70.33 progressive passes per 90 whereas the league average is 72.63
- Lack of cover in the middle particularly with nil options in the number 10 role with Eliano Reijnders departing

Portugal Segunda Liga

Farense

- They have an average possession of 52.9% this season
- They attempt 61.09 progressive passes per 90 whereas the league average is 64.04
- 4 of their 7 midfield options are departing on a free transfer this summer

Academico Viseu

- They have an average possession of 51.5% this season
- They attempt 62.23 progressive passes per 90 whereas the league average is 64.04
- 6 midfielders are seeing their contract expiring in the summer and couple of them are past their prime years

Benfica II

- They have an average possession of 54.3% this season
- They attempt 61.75 progressive passes per 90 whereas the league average is 64.04
- High scope for development and eventually an opportunity for him to reach his potential



FC SEOUL



SOUTH KOREA

SEONG-JIN KANG

SCOUT REPORT

JUNE 2023



Seong-jin Kang

FC Seoul

Category	Description	Points
International Appearances	Korea Republic: 10%	0
Domestic Minutes	Band 6: 45%	0
Continental Minutes	No data	0
League Position	Seoul Korea Republic K League 1 - #8	0
Continental Progression	No data	0
League Quality	K League 1	2
Total	Ineligible	2

This calculation is based on rules agreed by the FA and the Home Office for players to play in England. There will be edge cases and different interpretations. Our Governing Body Endorsement (GBE) status tool should be used as a guide to assess the likelihood of a player meeting the criteria, rather than a definitive assessment. GBE criteria are regularly reviewed by the FA and Home Office. Any changes will be incorporated into our calculations when they are announced.

NB: Our calculations don't currently take into account injury data or, for players under 21, any additional points from the youth criteria. There are variations to the GBE criteria for players to play in Scotland and details can be found on the Scottish FA website.

TFA

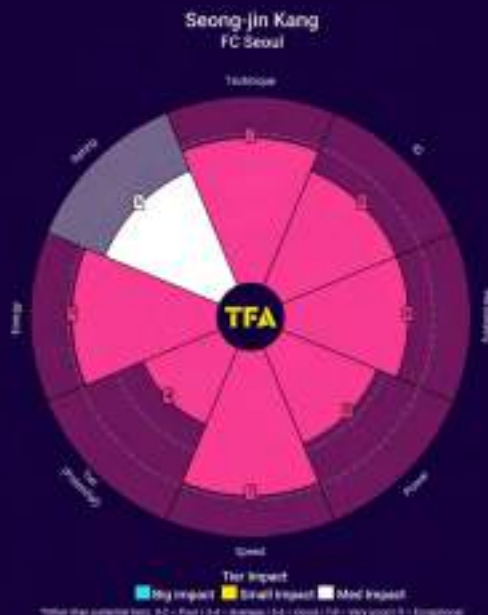

Seong-jin Kang is a 20-year-old right winger. He is quick and has the technique to take on players. With a strong left foot, he looks to get the ball on his primary foot to contribute in the final third. He needs to work on his physique to be able to sustain himself at a higher level but certainly has the technique to compensate for it. He is a creative player in the final third and also has an eye for a goal.

Exhibits promising defensive work as he looks to track back and help out his full-back. His decision-making while indulging in tackles is something he needs to work on as he can be a little too aggressive. In general, his work off the ball seems to be a standout feature of his game.

T - Technique I - IQ (football intelligence) P - Personality P - Power S - Speed T - Tier (potential Tier - see explainer) E - Energy
R - Rating (Big, Medium, Small) if he moved to that Tier today

Score explanations (other than potential tiers): 0-2 = poor 3-4 = average 5-6 = good 7-8 = very good 9 = exceptional

PLAYER PROFILE

Seong-jin Kang is a 20-year-old right winger who currently plays for FC Seoul in the Korea First Tier.

He is a left-footed player and has a good work ethic in offence and defence. He needs to gain more game time at the club level to be able to feature at a higher level.

He has a market value of €500,000

PLAYER HISTORY

Kang is a product of Sinjeong and joined his current club in 2016. He is currently with FC Seoul's first team and has a contract till December 2026.

SEONG-JIN KANG HEATMAP

All games from K League 1 2023, K League 1 2022

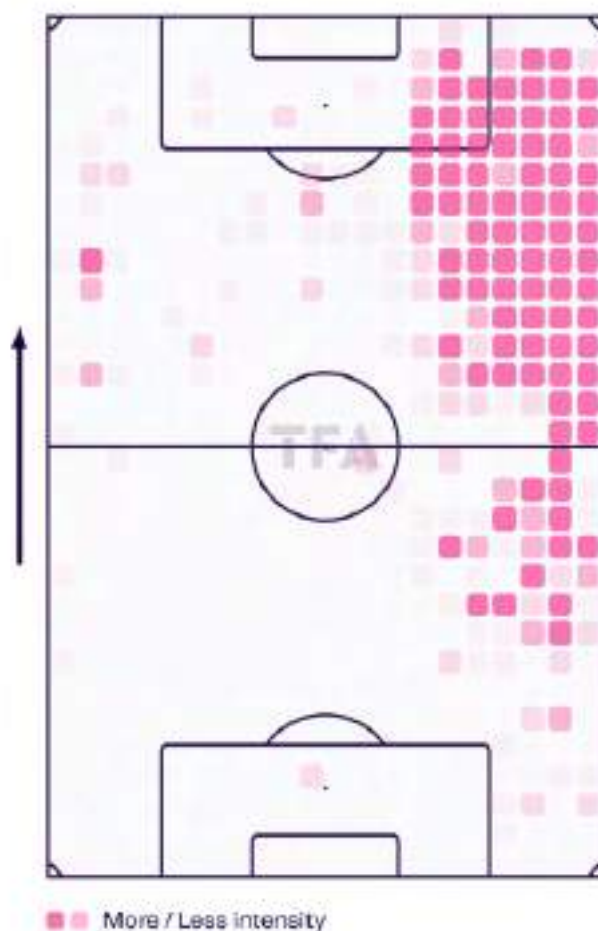

Kang Seong-Jin | RW | 1827 minutes played
Seoul | 19-years-old | Season 2022-23

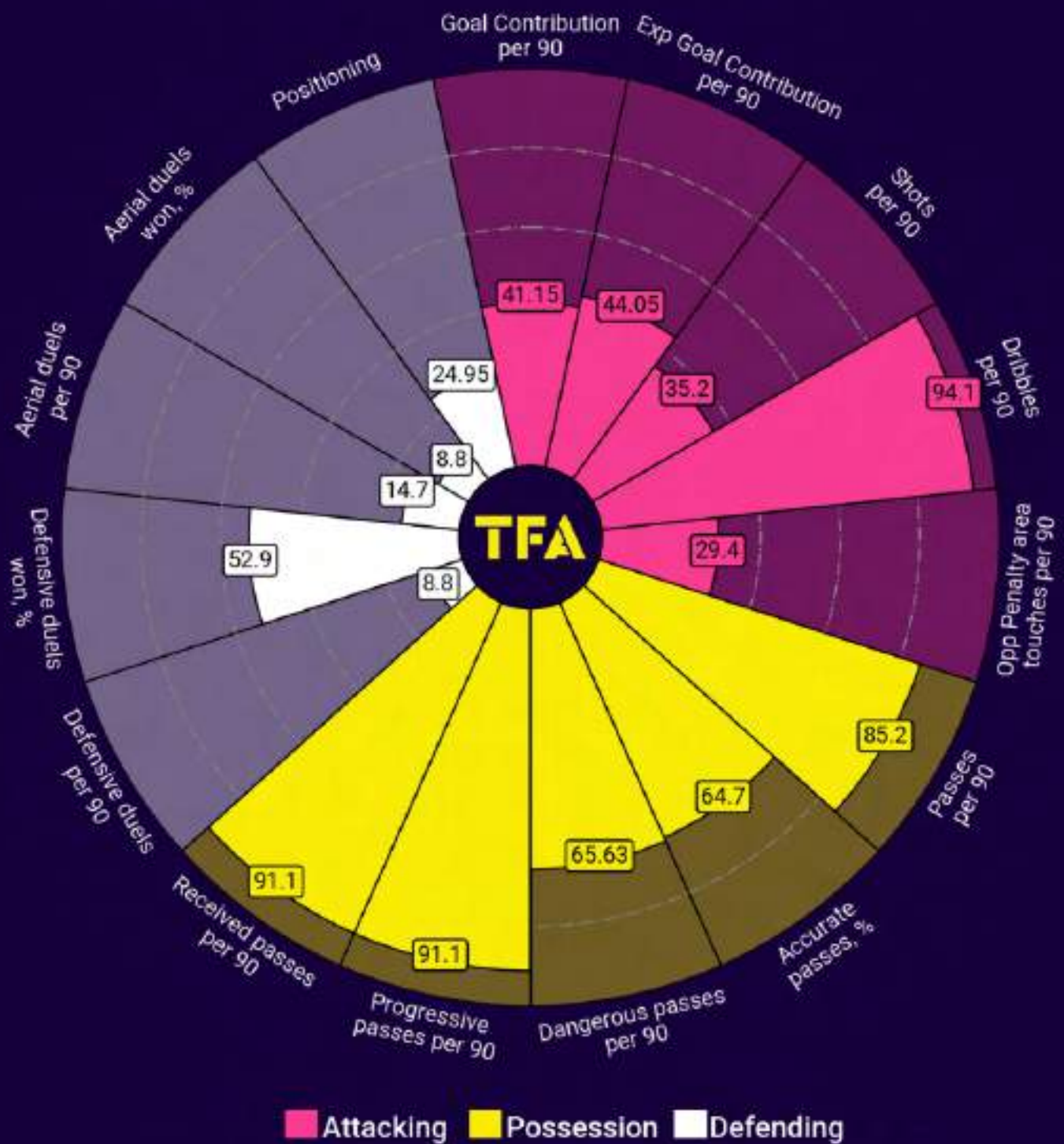

Percentile Rank vs RWs in Korea-K League 1-1 | Data from Season 2022-23

DEFENSIVE PHASE

Kang can read the game well and has a great understanding of the game. He knows when to press high and recognizes when to apply pressure as a team and as an individual. Kang has good awareness to protect and support the full-back. He also knows when to mark, step out, and press and when to track runners.

Kang can defend in 1v1 situations but needs to improve his tackling and decision-making. He has a habit of jumping into tackles or sometimes going too strongly to back the ball. He has excellent mobility and good off-the-ball movement. His tremendous work rate in attack and defence makes him a key figure. His willingness to press and hardworking nature is also highly appealing.

SEONG-JIN KANG DEFENSIVE TERRITORY

All games from K League 1 2023, K League 1 2022

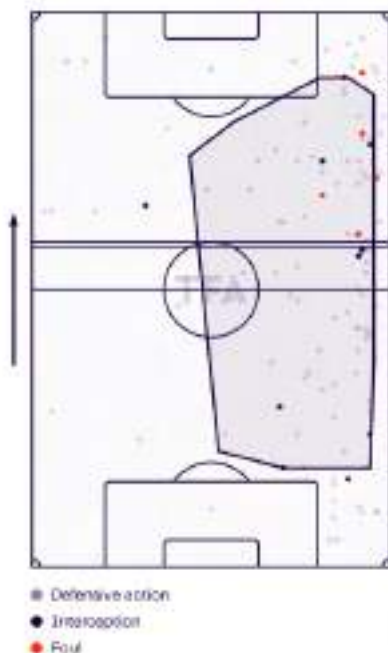

SEONG-JIN KANG HIGH REGAINS

All games from K League 1 2023, K League 1 2022



ATTACKING PHASE

Kang seems to trap the ball neatly and could receive the ball in half turns even under pressure. He can create time and space with his first touch and manipulate the ball accordingly. He can vary his positioning by playing not only wide but on the inside as well. He can make excellent movements to run behind the opposition's defence.

Dribbling seems to be his forte. With a strong left foot, he predominantly looks to cut inside but also has the ability to drive down the line when required. He is quick and skilful which enables him to beat his opponent in 1 v 1 situations.

Kang has various crossing skills and can execute them when static and while running. He is very clever in the penalty area but needs to be more decisive in the final third. He can combine effectively with 1-2's and disguised passes to create goalscoring opportunities. Kang is a highly creative player and constantly tries to make opportunities for his team.

Kang can also be viewed as a goalscoring winger considering his prowess in and around the box. He did make penetrating runs to get on the end of a cross or a final pass. Also has the ability to cut inside and whip shots towards the far post region.

SEONG-JIN KANG PASS MAP

All games from K League 1 2023, K League 1 2022

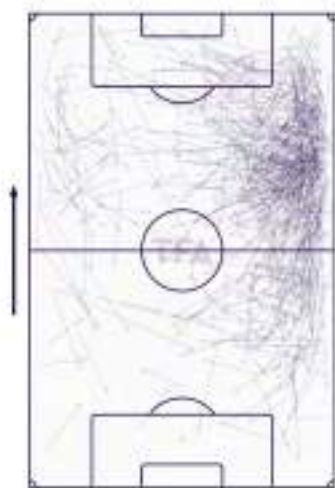

SEONG-JIN KANG PROGRESSIVE PASSES

All games from K League 1 2023, K League 1 2022

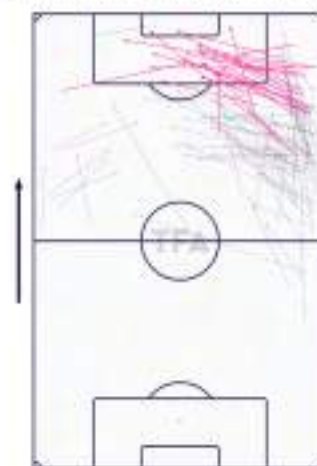

✓ Progressive pass
✓ Progressive pass into the penalty area

SEONG-JIN KANG WINGER ACTIONS

All games from K League 1 2023, K League 1 2022



SEONG-JIN KANG CROSSING ZONES

All games from K League 1 2023, K League 1 2022

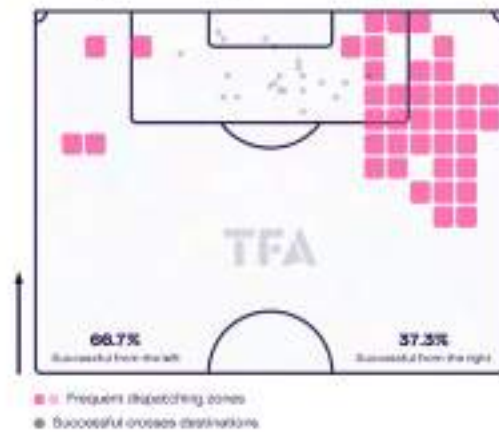

SEONG-JIN KANG SHOT ASSISTS

All games from K League 1 2022, K League 1 2023



SEONG-JIN KANG SHOTS

All games from K League 1 2023, K League 1 2022



SEONG-JIN KANG PENETRATING CARRIES

All games from K League 1 2023, K League 1 2022

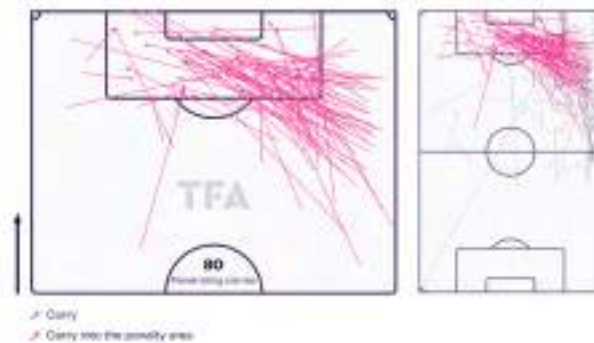

TRANSITIONS

Kang is actively involved in attacking transitions. He can exploit the space offered in the wide areas and also moves inside when needed to utilize the space between the channels. Without the ball, he positions himself in the defensive half but looks quick to make a supporting run to catch them on the break. He can also drive forward with the ball and progressive passes to release his attacking players.

Kang is alert during defensive transitions and looks quick to track back and support his back line. He is effective at making it 2 v 1 situations in the wide areas and displays good aggression with his counter-press. His slightly weak physique did let him down on occasions before he could win his challenge.

SEONG-JIN KANG BALL PROGRESSION

All games from K League 1 2022, K League 1 2023



PHYSICAL PROFILE

Kang stands at 180 cm and has a lean physique. He is a pacy winger and looks comfortable at catching the defence on the break. He is quite agile and is sensible at exploiting the space offered.

Uses his body balance and technique effectively but needs to work on his physique as he can be outmuscled. Promising work ethic and can be aggressive with his pressing as well.

He is a left-footed player.

SIMILAR PLAYERS USING XGOLD

xGOLD is our custom-built in-house tool that uses data to match player profiles

Suso
Sevilla
93% match

R. Mahrez
Man City
87% match

D. Kulusevski
Spurs
87% match



CLUB MATCHING METHODOLOGY

Our custom-built xGOLD tool has the ability to match players to clubs from a data-driven tactical fit perspective - we then take the initial shortlist and go into further scout-led filtering, considering the key points below.

A) Playing Style

Assessing teams by their playing style and finding a suitable match for Kang: Teams who attempt considerably fewer dribbles per 90 mins and progressive passes per 90 mins

B) Leagues

We are looking at options for teams in the top tier of Scotland, Austria and the second tier of Germany.

C) Statistics

Players statistically similar to Seong-jin Kang and whose contracts are ending and he could replace.

Scotland Premiership

Motherwell

- They attempt 18.48 dribbles per 90 mins with the league average at 23.24
- They attempt 64.97 progressive passes per 90 whereas the league average is 66.4
- Team fit shows a 76% match
- With Robbie Mahon leaving, he could be a quality replacement and is versatile enough to operate on the left

St. Mirren

- They attempt 17.88 dribbles per 90 mins with the league average at 23.24
- They attempt 60.43 progressive passes per 90 whereas the league average is 66.4
- Team fit shows a 70% match
- With the contracts of Jay Henderson and Ryan Flynn expiring, he could be a valuable replacement

St. Johnstone

- They attempt 19.85 dribbles per 90 mins with the league average at 23.24
- They attempt 61.9 progressive passes per 90 whereas the league average is 66.4
- Team fit shows an 83% match
- With all 3 wingers over 32, the youngster could be a key part of the rebuild

Austria Bundesliga

Ried

- They attempt 21.02 dribbles per 90 mins with the league average at 23.63
- They attempt 63.89 progressive passes per 90 whereas the league average is 70.05
- Team fit shows a 75% match
- His ability to play on either flank could be crucial and looks like a valuable back up option as well

Hartberg

- They attempt 22.05 dribbles per 90 mins with the league average at 23.63
- They attempt 69.02 progressive passes per 90 whereas the league average is 70.05
- Team fit shows a 75% match
- Lack of cover in the wide areas with only one player in the current squad under contract for next season

Austria Lustenau

- They attempt 23.43 dribbles per 90 mins with the league average at 23.63
- They attempt 64.15 progressive passes per 90 whereas the league average is 70.05
- Team fit shows a 73% match
- All 3 wide options see their contract expiring in the summer

Germany-2 Bundesliga

Fortuna Düsseldorf

- They attempt 22.07 dribbles per 90 mins with the league average at 22.47
- They attempt 65.64 progressive passes per 90 whereas the league average is 67.68
- Team fit shows an 81% match
- Felix Klaus is the only option on the right flank and is 30 yo and the youngster could be a reliable backup capable of pushing for a first-team spot

Kaiserslautern

- They attempt 17.31 dribbles per 90 mins with the league average at 22.47
- They attempt 64.96 progressive passes per 90 whereas the league average is 67.68
- Team fit shows a 77% match
- Ben Zolinski is 31yo and the youngster could be a reliable backup capable of pushing for a first team spot

Eintracht Braunschweig

- They attempt 20.57 dribbles per 90 mins with the league average at 22.47
- They attempt 63.88 progressive passes per 90 whereas the league average is 67.68
- Team fit shows an 80% match
- He could be a replacement for Tarsis Bonga who is departing as a free agent



BEITAR JERUSALEM



ISRAELI

ILAY MADMON

SCOUT REPORT

JUNE 2023



Ilay Madmon Beitar Jerusalem

Category	Description	Points
International Appearances	No data	0
Domestic Minutes	Band 6: 24%	0
Continental Minutes	No data	0
League Position	No data	0
Continental Progression	No data	0
League Quality	Ligat ha'Al	2
Total	Ineligible	2

This calculation is based on rules agreed by the FA and the Home Office for players to play in England. There will be edge cases and different interpretations. Our Governing Body Endorsement (GBE) status tool should be used as a guide to assess the likelihood of a player meeting the criteria, rather than a definitive assessment. GBE criteria are regularly reviewed by the FA and Home Office. Any changes will be incorporated into our calculations when they are announced.

NB: Our calculations don't currently take into account injury data or, for players under 21, any additional points from the youth criteria. There are variations to the GBE criteria for players to play in Scotland and details can be found on the Scottish FA website.

TFA



Ilay Madmon is a 20-year-old midfielder who stands out with primary as well as secondary tasks. He is quite composed on the ball and looks effective in ball retention. He is good with his tackles and has a direct style of play, and always looks to move forward.

Defensively, he reads the game well and positions himself accordingly. He tends to dominate in defensive duels with his strong physique but doesn't seem to lunge or mistime most of his tackles. His recovery attitude is quite good and covers for his teammates when they are out of position. A promising CM who has the attributes to play at a higher level.

T - Technique I - IQ (football intelligence) P - Personality P - Power S - Speed T - Tier (potential Tier - see explainer) E - Energy
R - Rating (Big, Medium, Small) If he moved to that Tier today

Score explanations (other than potential tiers): 0-2 - poor 3-4 - average 5-6 - good 7-8 - very good 9 - exceptional

PLAYER PROFILE

Ilay Madmon is a 20-year-old midfielder who currently plays for Beitar Jerusalem in Israel's Ligat ha'Al on loan from Hapoel Beer Sheva.

He is a right-footed player who can play on the right side of the midfield and also has the capability to play as a defensive midfielder.

He has a current market value of €300,000.

PLAYER HISTORY

Ilay Madmon, born 23 February 2003 is an Israeli professional footballer who plays as a centre-midfielder for Israeli Premier League club Beitar Jerusalem and captains the Israel national under-19 team.

I. MADMON HEATMAP

All games from Ligat ha'Al 2022/2023

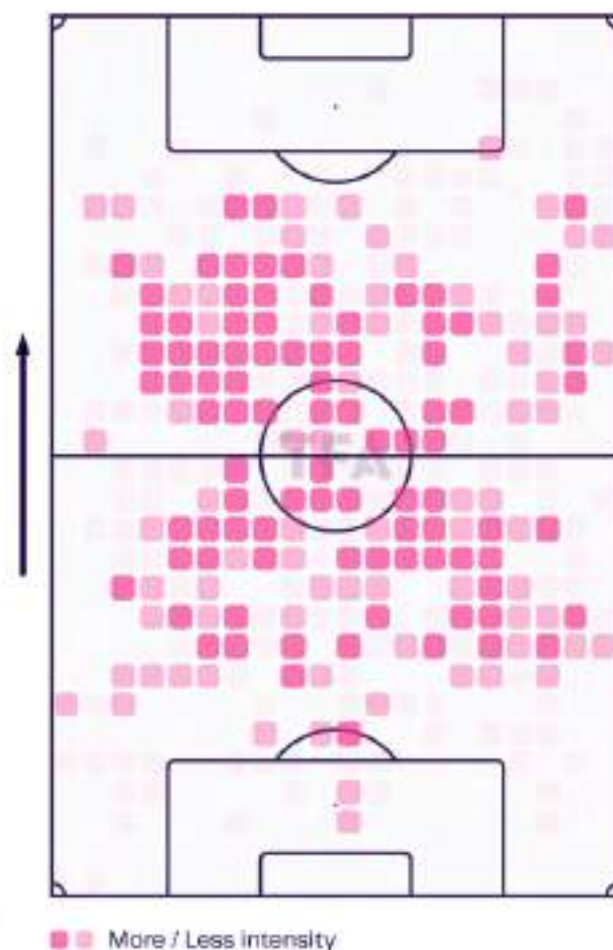

I. Madmon | RCM | 662 minutes played
 Beitar Jerusalem | 20-years-old | Season 2022-23

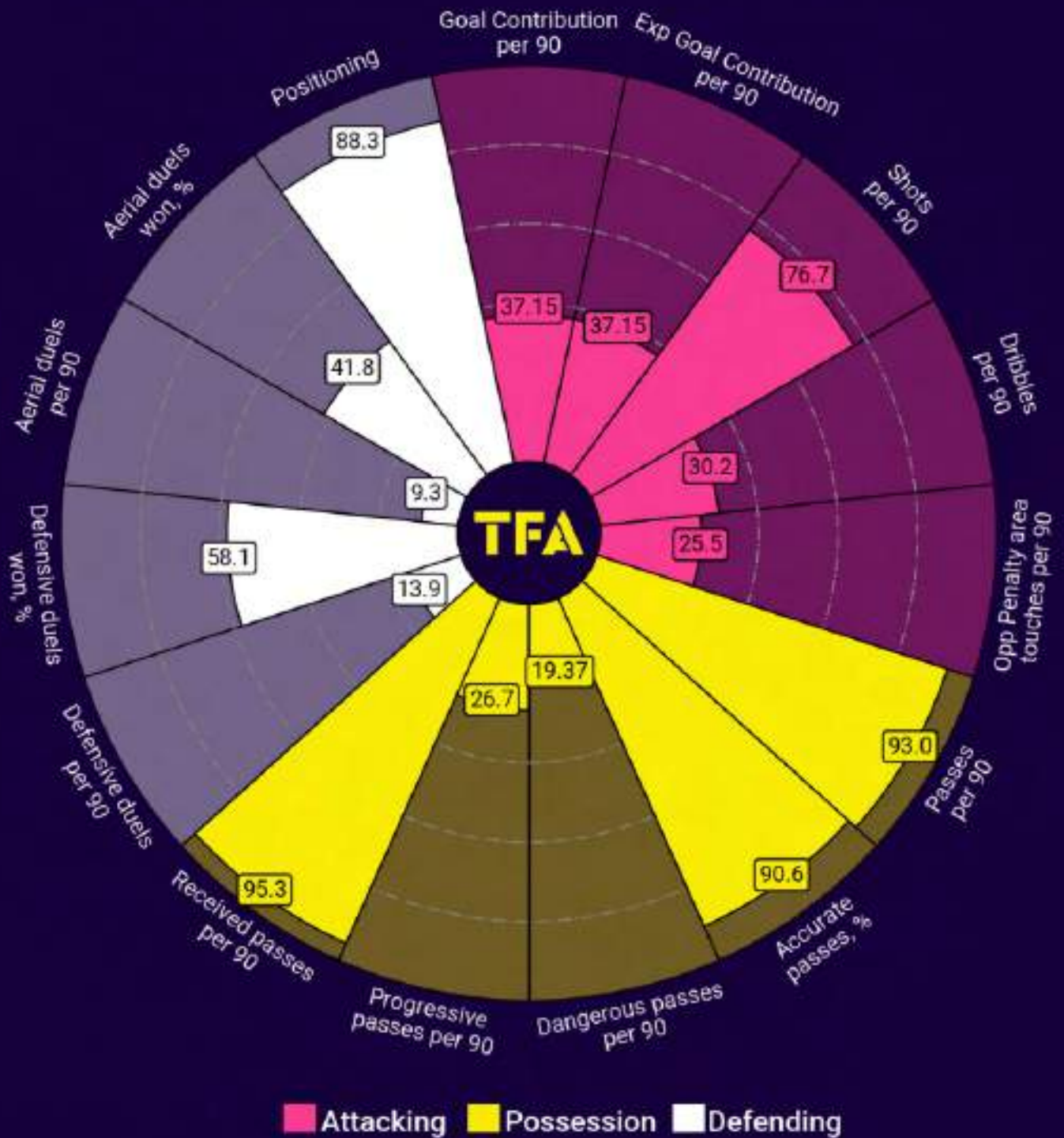

Percentile Rank vs RCMs in Israel-Ligat ha'Al-1 | Data from Season 2022-23

DEFENSIVE PHASE

Madmon is quick and aggressive in the defensive phases. He always looks to press his opponents and shows high intensity in defence.

Operating as an RDM / RCM, he covers the right flank very well and also moves out to protect the RB. He has a good tackling technique and is strong with his standing challenges. He also makes good use of his shoulder to shrug opponents off the ball while tracking back. Aerially looks solid, and wins a few duels in the defensive areas of the midfield third.

He mostly positions himself around the edge of the penalty box when his team is forced on the backfoot, and while he is good with marking the opponent, he at times commits himself too early to a challenge in a 1v1 situation. However, he deals with overall defensive situations well.

I. MADMON DEFENSIVE TERRITORY

All games from Ligat ha'Al 2022/2023

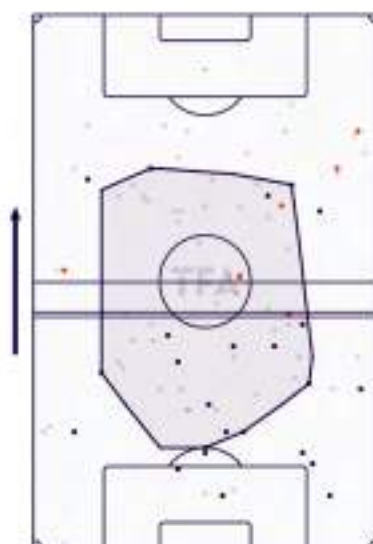

- Defensive action
- Interception
- Foul

I. MADMON HIGH REGAINS

All games from Ligat ha'Al 2022/2023



- Ball recovery
- Dangerous recovery (leading to a shot within 20 seconds)
- Counterpressing recovery (within 5 seconds after a possession loss)

ATTACKING PHASE

Madmon does a good job at the centre of the pitch to get on the ball and move the ball around. He is not a very technical passer but does enough to keep possession flowing for his team. His first touch is decent, and he mostly looks to release the ball quickly in a forward direction.

He depends on his movement to pick the ball up at various areas and then move it forward. He tends to stick to the right areas of the pitch and plays simple passes. He shows a good work rate to make himself visible even in higher areas but does not look to play penetrative passes. However, his driving runs with or without the ball allow his team to move forward into attack. He does attempt a few line-breaking passes into the striker at times, but isn't aware of him being marked tightly.

He shows decent aerial prowess and forms a part of the team's attacking setup from set pieces. Also, has the ability to shoot from distance and shows good power and technique.

I. MADMON PASS MAP

All games from Ligat ha'Al 2022/2023



I. MADMON PROGRESSIVE PASSES

All games from Ligat ha'Al 2022/2023



I. MADMON PENETRATING CARRIES

All games from Ligat ha'Al 2022/2023

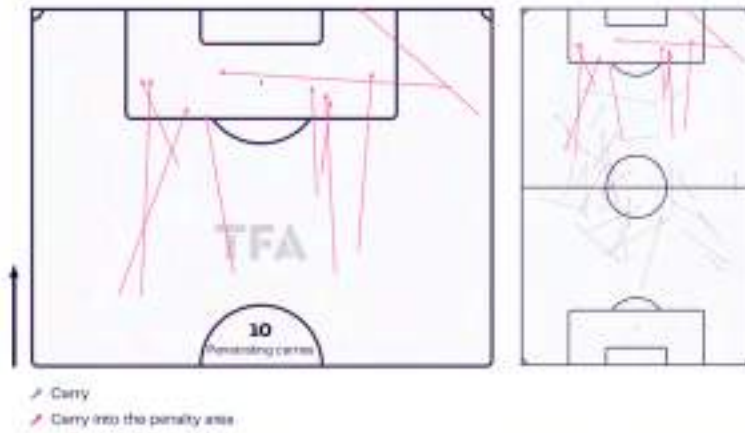

I. MADMON SHOT ASSISTS

All games from Ligat ha'Al 2022/2023



I. MADMON SHOTS

All games from Ligat ha'Al 2022/2023



TRANSITIONS

In attacking transitions, he looks to make quick exchanges and drive his team forward. He makes several driving forward runs on or off the ball and looks to receive the ball at a higher area. He does lack composure while playing out from the defensive third but plays a few good passes into space from the midfield third.

In defensive transitions, he shows a lot of aggression and is eager to counter-press. He can lose his composure at times and move into rash challenges but when he times these tackles well, he can recover the ball and break down opposition attacks. His positioning is good and can anticipate balls.

I. MADMON BALL PROGRESSION



PHYSICAL PROFILE

Madmon stands at 178 cm and has an athletic physique. He is strong in duels and doesn't get beaten easily in 1v 1 situations and also outmuscles his opponent comfortably. He also has a good leap to win a decent number of his headers despite not dominating in the air.

He looks like a hard-working player who is aware of his defensive positioning and covers the ground to help his back line. He can play at a high intensity as well.

He is a right-footed player.

SIMILAR PLAYERS USING XGOLD

xGOLD is our custom-built in-house tool that uses data to match player profiles

Exequiel Palacios

Bayer Leverkusen
87% match

Johann Lepenant

Olympique Lyonnais
83% match

Sebastian Rode

Eintracht Frankfurt
82% match

I. Madmon
Season 2022-23



E. Palacios
Season 2022-23



I. Madmon
Season 2022-23

J. Lepenant
Season 2022-23

I. Madmon
Season 2022-23

S. Rode
Season 2022-23



CLUB MATCHING METHODOLOGY

Our custom-built xGOLD tool has the ability to match players to clubs from a data-driven tactical fit perspective - we then take the initial shortlist and go into further scout-led filtering, considering the key points below.

A) Playing Style

Assessing teams by their playing style and finding a suitable match for Madmon:
Teams who average considerably low on passing accuracy and also defensive duels won percentage

B) Leagues

We are looking at options for teams in Denmark Superliga, Sweden Allsvenskan and Switzerland Super League

C) Statistics

Players statistically similar to Madmon and whose contracts are ending and he could replace.

Denmark Superliga

Viborg

- They have averaged 59.2 defensive duels per 90 mins at a success rate of 63.2%
- They have averaged 413.71 passes per 90mins at an accuracy rate of 83%
- Teamfit shows a 79% match
- Madmon would be a good match for Viborg as they need a player who can retain the ball in the middle of the park and who plays progressive passes with good accuracy.

Horsens

- They have averaged 72.22 defensive duels per 90 mins at a success rate of 64.9%
- They have averaged 328.69 passes per 90mins at an accuracy rate of 77.5%
- Teamfit shows a 75% match
- Horsens would be looking to add a right-sided midfielder to their team as the players in that position will be out of contract next year and he will be a good addition to the side.

OB

- They have averaged 64.01 defensive duels per 90 mins at a success rate of 61.2%
- They have averaged 414.76 passes per 90mins at an accuracy rate of 82.4%
- Teamfit shows a 75% match
- OB would be a very good fit for the youngster as one of the midfielders is leaving this summer and they would need to strengthen the squad.

Sweden Allsvenskan

Sirius

- They have averaged 58.45 defensive duels per 90 mins at a success rate of 63.6%
- They have averaged 447.7 passes per 90mins at an accuracy rate of 85.2%
- Teamfit shows a 80% match
- IK Sirius needs a midfielder who can play on the right side of the midfield.
- Madmon would be a good fit as he is good with the ball and can break lines and plays a high number of progressive passes.

Hammarby

- They have averaged 59.12 defensive duels per 90 mins at a success rate of 61.4%
- They have averaged 453.13 passes per 90mins at an accuracy rate of 81.6%
- Teamfit shows a 76% match
- Hammarby would be looking for a midfielder who is good in 1v1 duels and also who can recycle the ball well.
- Two of their midfielder are done with their loan spells and one is injured.

Kalmar

- They have averaged 61.56 defensive duels per 90 mins at a success rate of 60.4%
- They have averaged 493.5 passes per 90mins at an accuracy rate of 85.9%
- Teamfit shows a 75% match
- Two of their midfielders would be leaving this year and they would require strengthening in the midfield department.
- A very good opportunity for Madmon to create an impact in the first team.

Switzerland Super League

Sion

- They have averaged 61.39 defensive duels per 90 mins at a success rate of 59.8.4%
- They have averaged 336.55 passes per 90mins at an accuracy rate of 80%
- Teamfit shows a 78% match
- Multiple midfielders are done with their loan spells at Sion and one of their main midfielders is injured.
- Would be a good opportunity for Madmon to make an impact on the team.

Servette

- They have averaged 60.72 defensive duels per 90 mins at a success rate of 61.1%
- They have averaged 370.07 passes per 90mins at an accuracy rate of 80.7%
- Teamfit shows a 75% match
- Servette are short on midfielders as multiple players are injured and one is out of contract this summer.
- Madmon can be a starter for the club as he has the qualities to elevate the team.

Lugano

- They have averaged 60.65 defensive duels per 90 mins at a success rate of 62.3%
- They have averaged 407.4 passes per 90mins at an accuracy rate of 83.6%
- Teamfit shows a 76% match
- Two of their midfielders are above 30 and of them will be out of contract this summer.
- Madmon would be a very good addition to the team as they would be looking to add young midfielders to the team.



ATLANTA UNITED



AMERICA

CALEB WILEY

SCOUT REPORT

JUNE 2023



Caleb Wiley Atlanta United FC

Category	Description	Points
International Appearances	No data	0
Domestic Minutes	Band 4: 0%	0
Continental Minutes	No data	0
League Position	Atlanta United: MLS - #22	0
Continental Progression	No data	0
League Quality	MLS	6
Total	Ineligible	6

This calculation is based on rules agreed by the FA and the Home Office for players to play in England. There will be edge cases and different interpretations. Our Governing Body Endorsement (GBE) status tool should be used as a guide to assess the likelihood of a player meeting the criteria, rather than a definitive assessment. GBE criteria are regularly reviewed by the FA and Home Office. Any changes will be incorporated into our calculations when they are announced.

NB: Our calculations don't currently take into account injury data or, for players under 21, any additional points from the youth criteria. There are variations to the GBE criteria for players to play in Scotland and details can be found on the Scottish FA website.

TFA

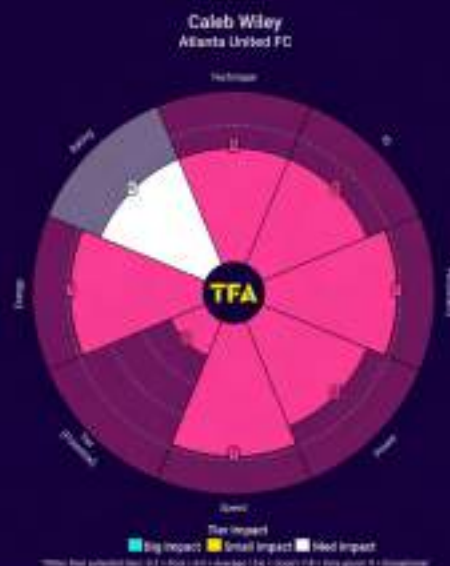

Caleb Wiley is a promising young left back who also looked versatile enough to play as a winger. He was very attack-minded and constantly looked to get forward and link up play. He also managed to get into the opposition box unmarked and seemed to be a goal threat from close range. Wiley also does well to create chances for his teammates with his crosses although he does need to work on increasing the volume of these efforts. He was defensively sound as well and looked to quickly track back when needed. Wiley was a competent figure during his 1v1 duels and stuck close to his man here, although he does need to become more aggression with his tackles. Despite this, he has the basic traits to turn into a more classy full back and has the potential to warrant a bigger move soon.

T = Technique I = IQ (Football intelligence) P = Personality P = Power S = Speed T = Tier (potential Tier - see explainer) E = Energy
R = Rating (Big, Medium, Small) if he moved to that Tier today

Score explanations (other than potential tiers): 0-2 = poor 3-4 = average 5-6 = good 7-8 = very good 9 = exceptional

PLAYER PROFILE

Caleb Wiley is an 18-year-old left-back who plays for Atlanta United in the MLS, the highest tier of American football.

He is predominantly left-footed and looked capable of playing as a left winger or left midfielder as well. He is also a current senior USA international.

Wiley has a current market value of €4,000,000.

PLAYER HISTORY

Wiley is a product of the Atlanta United academy and rose up the ranks before settling in with the senior side in the 21/22 season.

C. WILEY HEATMAP

All games from MLS 2023, MLS 2022

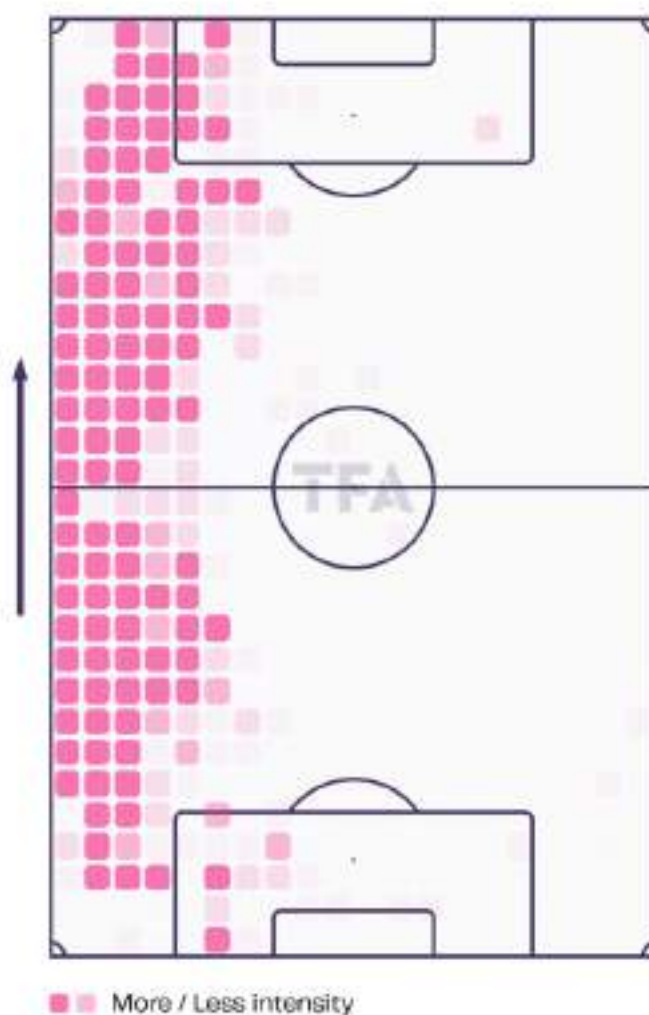

C. Wiley | LB | 1677 minutes played
Atlanta United | 18-years-old | Season 2022-23

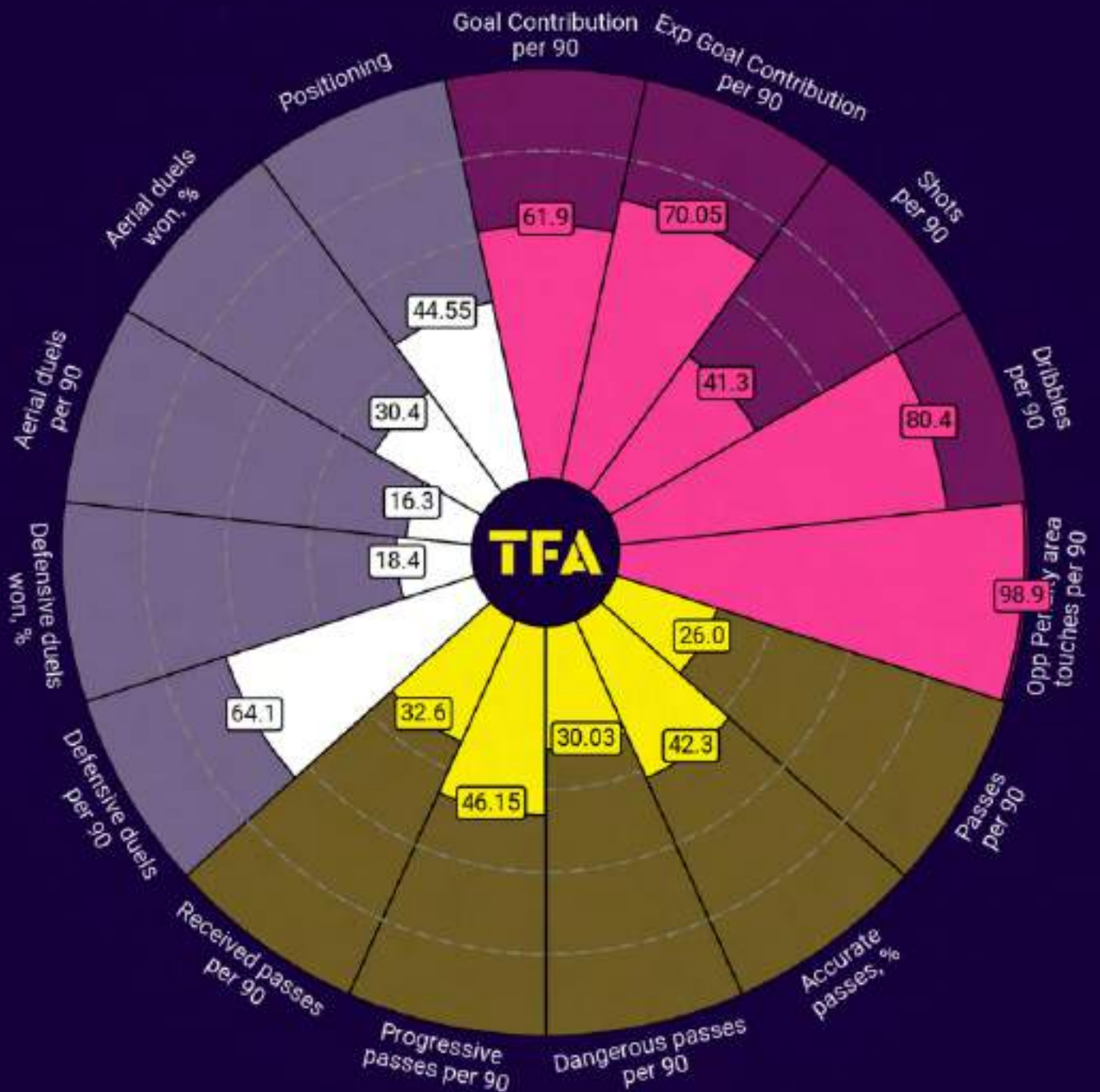

Attacking **Possession** **Defending**

Percentile Rank vs LBs in USA-MLS-1/ Data from Season 2022-23

DEFENSIVE PHASE

Wiley looked hard to beat when it came to his 1v1 duels and often looked to be agile enough to stay close to his man. He also seemed sharp on the turn and looked to usher opponents away from his box. Despite this, he can be a little hesitant to put a foot in to retrieve the ball and did not seem like a dominant ball winner at the moment.

Wiley used his pace well to make up for lost ground and seemed quick to step off his line to intercept opposition passes when possible. He also tried to quickly close down open spaces higher up the pitch but only looked to do so when deployed in a more advanced role.

He does need to show more aggression when going into defensive duels though but did seem to be a composed figure at the back. Wiley can be a little clumsy at times when defending in close quarters and did show a tendency to push his man from behind.

C. WILEY DEFENSIVE TERRITORY

All games from MLS 2022, MLS 2023



- Defensive action
- Interception
- Foul

C. WILEY HIGH REGAINS

All games from MLS 2022, MLS 2023



- Ball recovery
- Dangerous recovery (leading to a shot within 30 seconds)
- Counterpressing recovery (within 5 seconds after a possession loss)

ATTACKING PHASE

Wiley showcased a neat first touch and seemed to be at ease when receiving the ball under pressure. He seemed to be an offensive-minded player and was often seen linking up play higher up the pitch, while also looking versatile enough to play as a winger when needed.

Wiley seemed to be a constant presence inside the opposition box and was a composed finisher from close range. He does well to use his pace to run onto through balls and often looked to go for placement over power.

He also looked to be a decent crosser and often managed to pick out a teammate with his whipped balls. He does need to improve the frequency of these crosses but often showcased good levels of accuracy and technique when doing so on the move as well.

Wiley did look eager to take on opponents and showed some excellent change of pace to beat his marker up close but does need to be more direct when carrying possession forward. Despite this, he did look confident on the move and often helped to drive the ball into the final third. Wiley also needs to shoot from outside the box more often as he has the technique to hit the target from this range.

C. WILEY PASS MAP

All games from MLS 2023, MLS 2022

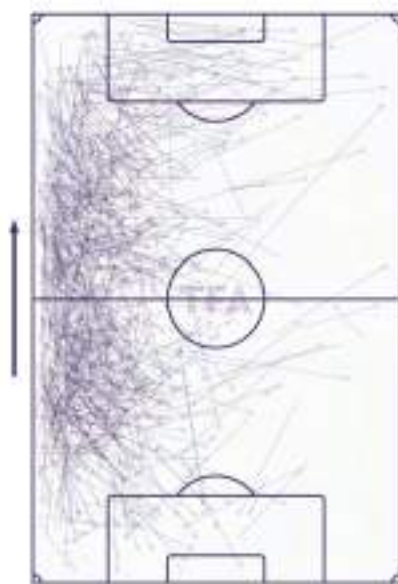

✓ Successful pass

C. WILEY PROGRESSIVE PASSES

All games from MLS 2022, MLS 2023



✓ Progressive pass

✓ Progressive pass into the penalty area

C. WILEY WINGER ACTIONS

All games from MLS 2023, MLS 2022



C. WILEY PENETRATING CARRIES

All games from MLS 2022, MLS 2023



C. WILEY SHOT ASSISTS

All games from MLS 2022, MLS 2023



C. WILEY CROSSING ZONES

All games from MLS 2023, MLS 2022

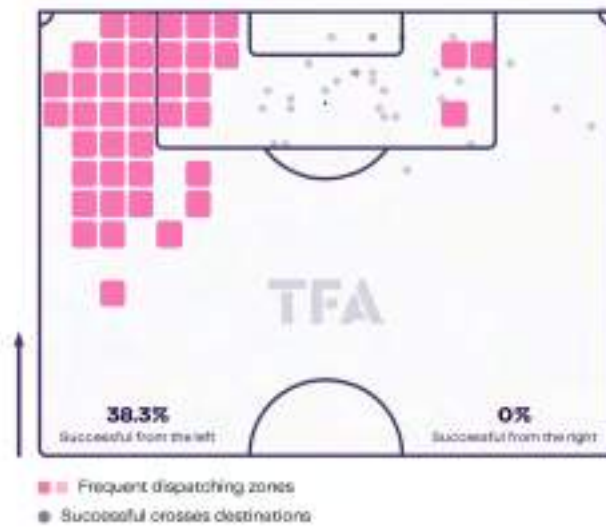

TRANSITIONS

When it came to their offensive transitions, Wiley was really energetic and frequently does well to quickly get forward. He was a mobile target during their counterattacks due to his eagerness to rush onto through balls from deep, and he also does well to play quick 1-2s to link up play in confined spaces. Wiley was a decent dribbler as well and helped move the ball forward when needed, while his off ball movement here often stretched the opposition line. He also does well to get into the box at the end of these phases and often tested the keeper from range.

Wiley often managed to track back in time during their defensive transitions and does well to take up strong positions at the back. He does well to track runners closely and often managed to get across to them using his pace. Wiley also does well to shift back into his box during opposition counters and looked to make some decent interceptions in the area.

PHYSICAL PROFILE

Standing at a fairly decent height of 178cm, Wiley was capable in the air but far from being a dominant figure here. He did win most of his headers but does need to make better contact with the ball when in the air.

Wiley possessed a lean physique and often combined this with a very agile frame. He was quick off his mark and looked capable of holding onto these speeds for longer distances.

Wiley also looked to be fairly strong on and off the ball but does need to showcase more aggression when going in a physical duel.

C. WILEY BALL PROGRESSION



SIMILAR PLAYERS USING XGOLD

xGOLD is our custom-built in-house tool that uses data to match player profiles

Emerson Palmieri

West Ham United
85% match

Hugo Bueno

Wolverhampton Wanderers
84% match

Romain Perraud

Southampton F.C.
83% match



CLUB MATCHING METHODOLOGY

Our custom-built xGOLD tool has the ability to match players to clubs from a data-driven tactical fit perspective - we then take the initial shortlist and go into further scout-led filtering, considering the key points below.

A) Playing Style

Our custom-built xGOLD tool has the ability to match players to clubs from a data-driven tactical fit perspective - we then take the initial shortlist and go into further scout-led filtering, considering the key points below.

B) Leagues

We are looking at options for teams in Belgium Jupiler Pro League, Netherlands Eredivisie and Turkey Super Lig

C) Statistics

Players statistically similar to Wiley and whose contracts are ending and he could replace.

Belgium Jupiler Pro League

OH Leuven

- They have averaged 56.88 xG per 90mins
- They have averaged 70.69 defensive duels per 90mins
- Teamfit shows an 81% match
- Leuven needs to strengthen its left-back department as they only have one left-back.
- Wiley would be a great addition to the squad and would certainly improve the team with his attacking mindset.

Genk

- They have averaged 50.88 xG per 90mins
- They have averaged 61.97 defensive duels per 90mins
- Teamfit shows a 78% match
- Their main left-back is out of contract this summer and they would be looking to replace him and strengthen their squad.
- Wiley will be a really good option for them to look at as he would suit their style of play.

Charleroi

- They have averaged 50.71 xG per 90mins
- They have averaged 66.01 defensive duels per 90mins
- Teamfit shows an 80% match
- Charleroi will certainly be looking at full-back options as their left-back is out of contract this summer and the full-back is injured.
- Wiley would be a handy option to buy this summer as he can play in multiple positions.

Netherlands Eredivisie

Sparta Rotterdam

- They have averaged 56.71 xG per 90mins
- They have averaged 57.56 defensive duels per 90mins
- Teamfit shows an 80% match
- Rotterdam would be looking to add a left-back this summer as one of their LB is out of contract this summer and the other is moving to another club.
- This a great opportunity for Wiley and the club if they can sign him in this window.

NEC

- They have averaged 55.68 xG per 90mins
- They have averaged 61.09 defensive duels per 90mins
- Teamfit shows a 78% match
- one of the LBs is moving to another club and the other is injured.
- Wiley can be a good addition for NEC who would be actively looking for a LB this summer.

Heerenveen

- They have averaged 47.96 xG per 90mins
- They have averaged 60.73 defensive duels per 90mins
- Teamfit shows a 79% match
- Wiley is a young attacking left-back who can play in multiple positions such as a wing-back and a left winger as well.
- He would be a versatile option for Heerenveen this summer.

Turkey Super Lig

Alanyaspor

- They have averaged 554.34 xG per 90mins
- They have averaged 60.74 defensive duels per 90mins
- Teamfit shows a 79% match
- One of the LB's contract is expiring this summer and the club will be looking to replace him.
- Wiley can add good squad depth to the team by showcasing his versatility

Konyaspor

- They have averaged 59.58 xG per 90mins
- They have averaged 55.33 defensive duels per 90mins
- Teamfit shows a 76% match
- Their main left-back is 33
- Wiley would certainly be a good option for the club as he is young and plays with an attacking mindset.

Antalyaspor

- They have averaged 52.23 xG per 90mins
- They have averaged 57.99 defensive duels per 90mins
- Teamfit shows a 76% match
- One of their left-back is 34 and the other one is out of contract this summer.
- The club will be looking to add a young full-back and Wiley would be an ideal option.



YOKOHAMA F. MARINOS



JAPAN

SCOUT REPORT

RIKU YAMANE

JUNE 2023



Riku Yamane Yokohama F. Marinos

Category	Description	Points
International Appearances	No data	0
Domestic Minutes	Band 6: 13%	0
Continental Minutes	No data	0
League Position	Yokohama F. Marinos: Japan J1 League 1 Title winner	
Continental Progression	No data	0
League Quality	J1 League	2
Total	Ineligible	3

This calculation is based on rules agreed by the FA and the Home Office for players to play in England. There will be edge cases and different interpretations. Our Governing Body Endorsement (GBE) status tool should be used as a guide to assess the likelihood of a player meeting the criteria, rather than a definitive assessment. GBE criteria are regularly reviewed by the FA and Home Office. Any changes will be incorporated into our calculations when they are announced.

NB: Our calculations don't currently take into account injury data or, for players under 21, any additional points from the youth criteria. There are variations to the GBE criteria for players to play in Scotland and details can be found on the Scottish FA website.

TFA

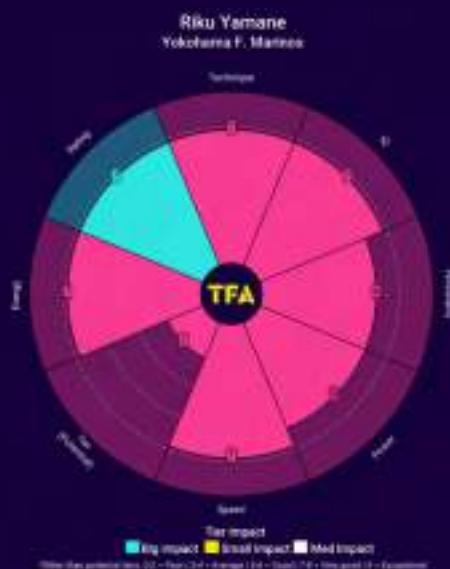

Riku Yamane is a 19-year-old midfielder who often plays as a pivot for his team as he drops deep to receive possession and looks to supply the ball to his teammates. He is a technically astute midfielder with the ability to play balls out wide or advance play up the field with a smart pass. He has a good passing range and is very composed on the ball as he tries to dictate the play. Defensively, he takes up good positions in front of his backline but is most effective if partnered with a more physical midfielder who can cover for him when required.

T = Technique I = IQ (football intelligence) P = Personality P = Power S = Speed T = Tier (potential Tier - see explainer) E = Energy
 R = Rating (Big, Medium, Small) if he moved to that Tier today

Score explanations (other than potential tiers): 0-2 = poor 3-4 = average 5-6 = good 7-8 = very good 9 = exceptional

PLAYER PROFILE

Riku Yamane is a 19-year-old Japanese footballer who plays for Yokohama F. Marinos in the J1 League, the top tier in Japan.

Yamane is predominantly right-footed and is a central midfielder. He is quite the utility player as he is also comfortable being deployed as a full-back if required.

His current Transfermarkt value is €200,000.

PLAYER HISTORY

Yamane is a product of the Yokohama F. Marinos youth system and was promoted to the senior team in 2022. He also featured for the Japanese U20 team in the U20 World Cup and Asian Cup.

R. YAMANE HEATMAP

All games from AFC U20 Asian Cup 2023 Uzbekistan, J-League Cup 2023, J1 League 2022

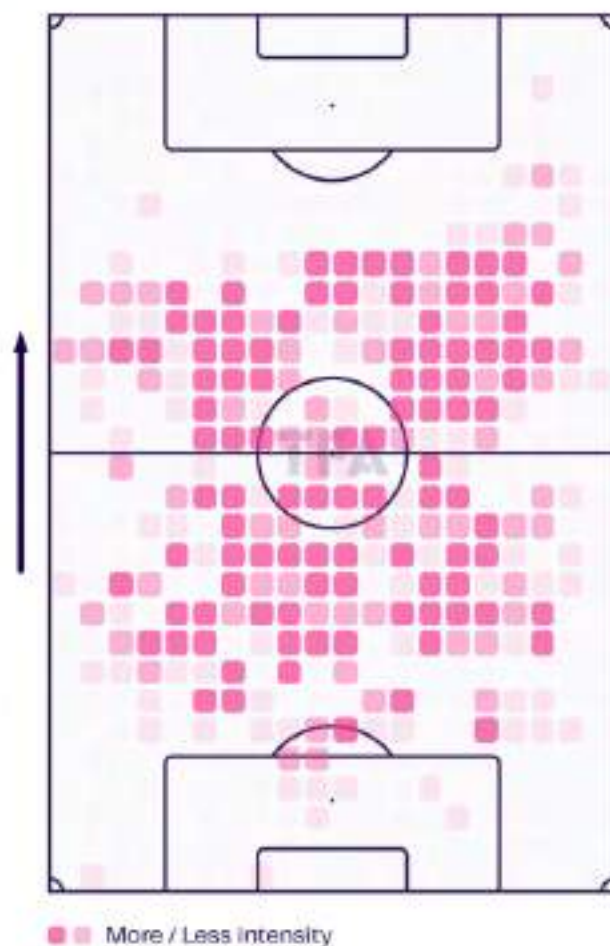

R. Yamane | LDM | 539 minutes played
 Yokohama F. Marinos | 19-years-old | Season 2022-23

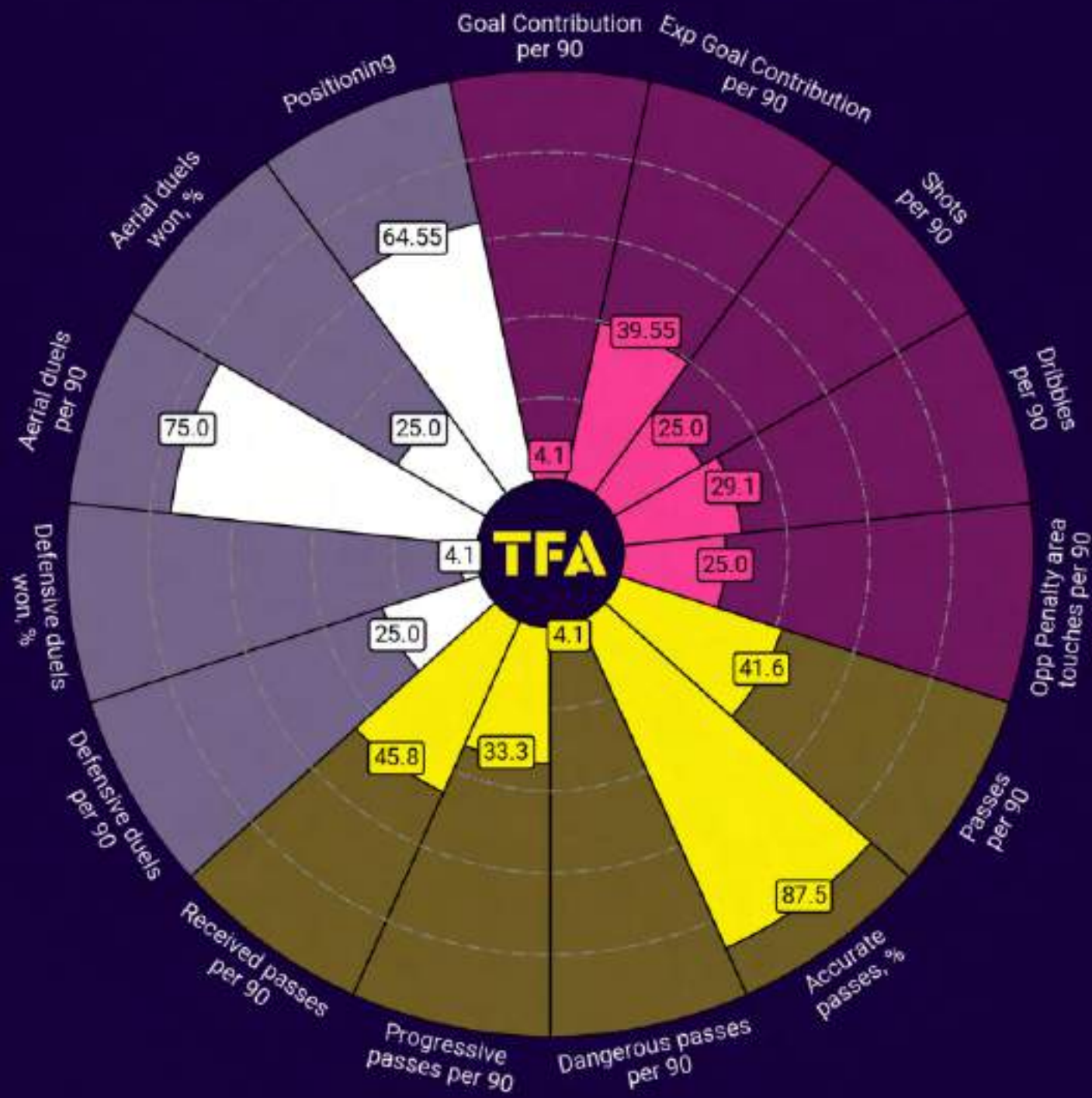

Attacking Possession Defending

Percentile Rank vs LDMs in Japan-J1 League-1| Data from Season 2022-23

DEFENSIVE PHASE

Yamane does well in 1v1 situations and has good agility and turns with an opponent, also showing good balance due to his low centre of gravity. He can be very tenacious while challenging for the ball and does not let the opponent go by easily. He does not have a very powerful physique but can be aggressive while competing for loose balls.

His main concern is screening the back four, and he will only step if there is ample cover. He will drop into the back line and will make blocks and interceptions in front of them too. He will also move out into wider areas to help out his full-backs when needed.

R. YAMANE DEFENSIVE TERRITORY

All games from AFC U20 Asian Cup 2023 Uzbekistan, J-League Cup 2023, J1 League 2022

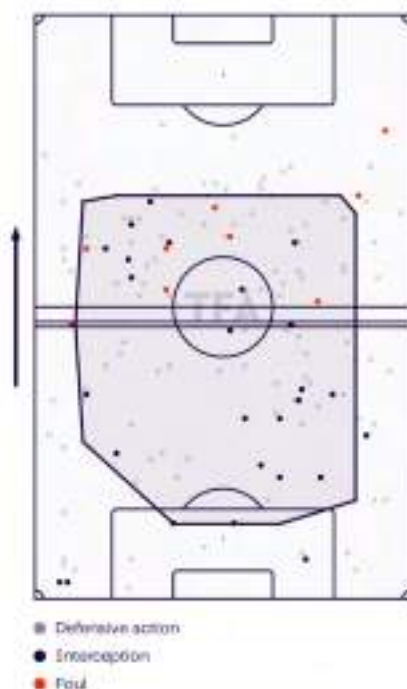

R. YAMANE HIGH REGAINS

All games from AFC U20 Asian Cup 2023 Uzbekistan, J-League Cup 2023, J1 League 2022

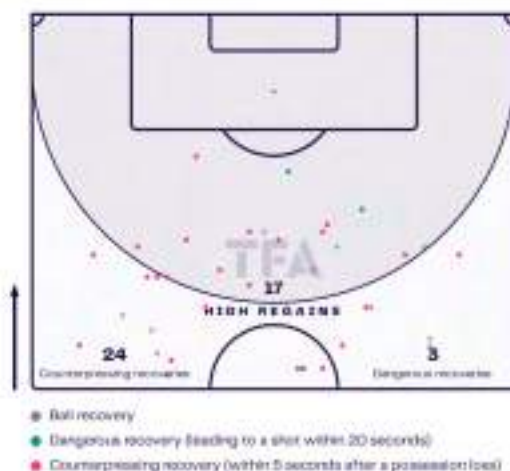

ATTACKING PHASE

Yamane frequently scans even before receiving the ball and often drops deep to receive from his defenders, where he can dictate possession in more space. As the ball is progressed further he may shift into different positions across the width of the pitch but always falls back to anchoring possession.

He looks like a technically adept midfielder who showcased a good receiving technique and can play off limited touches when required. He constantly checks his shoulder before receiving and does well to turn away from an opponent closing down on him. He was secure with his passes in the build-up and also plays these passes with good ball speed. He does not look to play final passes himself, instead demonstrated the ability to break lines from deeper areas and can play progressive passes to move the ball into the opposition half. He moves the ball laterally where necessary and recognizes when to retain the ball and move it away from pressure.

He may carry the ball forward but doesn't do so at an overly quick pace. He keeps his head up and looks for a forward pass option. He is able to quickly change direction away from a press and safely offloads possession towards a teammate.

R. YAMANE PASS MAP

All games from AFC U20 Asian Cup 2023 Uzbekistan, J-League Cup 2023, J League 2022

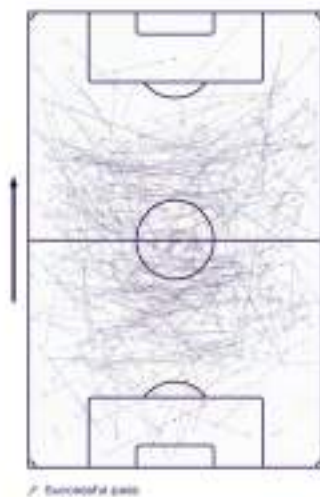

R. YAMANE PROGRESSIVE PASSES

All games from AFC U20 Asian Cup 2023 Uzbekistan, J-League Cup 2023, J League 2022



R. YAMANE SHOTS

All games from AFC U20 Asian Cup 2023 Uzbekistan, J-League Cup 2023, J League 2022



R. YAMANE SHOT ASSISTS

All games from AFC U20 Asian Cup 2023 Uzbekistan, J-League Cup 2023, J League 2022



R. YAMANE PENETRATING CARRIES

All games from AFC U20 Asian Cup 2023 Uzbekistan, J-League Cup 2023, J League 2022

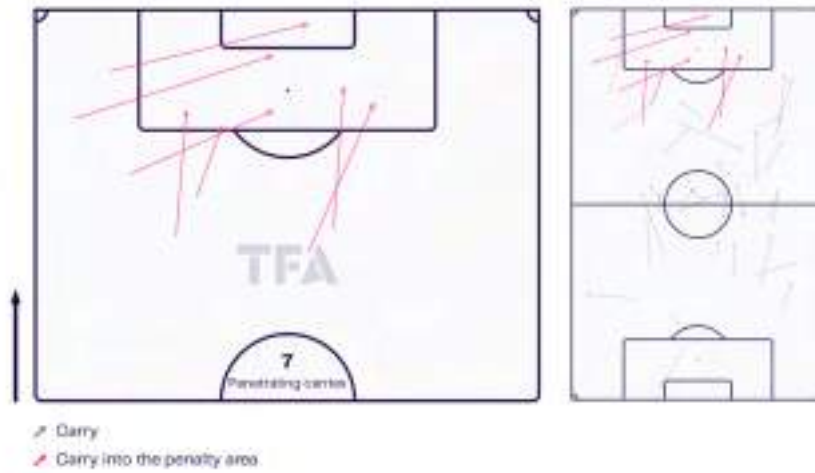

TRANSITIONS

In attacking transitions, he takes a variety of approaches. He also showed a good understanding of when he needs to retain possession and can slow down the tempo for his team. He rarely looked to play a final pass in these occasions but can play quick progressive passes to move the ball higher up the pitch.

He reacts well to turnovers and also tracks his man diligently. He has good anticipation skills and does very well at intercepting passes to break up play. He usually looks to maintain his position in front of the backline and does not try to be too aggressive in stepping out to press an opponent.

R. YAMANE BALL PROGRESSION

All games from AFC U20 Asian Cup 2023 Uzbekistan, J-League Cup 2023, J-League 2022



PHYSICAL PROFILE

Yamane stands at 173cm in height and has a fairly skinny build. He could still improve his physique in the coming years.

He is a very mobile player who moves across the pitch well and also has a good pace. He looks very solid and stable in duels, something that could continue to improve in the short term.

He rarely gets involved with aerial duels because of his short frame and is mostly ineffective when he does. He has average spring to his leap and isn't physically strong when competing for duels.

SIMILAR PLAYERS USING XGOLD

xGOLD is our custom-built in-house tool that uses data to match player profiles

Fabinho

Liverpool
75% match

Moisés Caicedo

Brighton
74% match

Boubacar Kamara

Aston Villa
74% match

R. Yamane
Yokohama F. Marinos

Fabinho
Liverpool

R. Yamane
Season 2022-23

M. Caicedo
Season 2022-23

R. Yamane
Season 2022-23

B. Kamara
Season 2022-23



CLUB MATCHING METHODOLOGY

Our custom-built xGOLD tool has the ability to match players to clubs from a data-driven tactical fit perspective - we then take the initial shortlist and go into further scout-led filtering, considering the key points below.

A) Playing Style

Assessing teams by their playing style and finding a suitable match for Yamane: Teams who average considerably low on progressive passes per 90 and also aerial duels won per 90

B) Leagues

We are looking at options for teams in Belgium's Jupiler Pro League, Netherlands Eredivisie and Turkey Super Lig

C) Statistics

Players statistically similar to Yamane and whose contracts are ending and he could replace.

Belgium Jupiler Pro League

Union Saint-Gilloise

- They have averaged 64.3 progressive passes per 90mins
- They have averaged 58.89 aerial duels per 90mins
- Teamfit shows a 79% match
- USG need a backup in the DM position
- Yamane would be an ideal player as his tenacity and good ball control will strengthen the first team and the squad

Charleroi

- They have averaged 63.82 progressive passes per 90mins
- They have averaged 26.77 aerial duels per 90mins
- Teamfit shows a 78% match
- The club will be looking for a young defensive midfielder as one of the DMs is 34 years old.
- Yamane will be a good prospect for the club and could have a great impact on the team.

Genk

- They have averaged 64.63 progressive passes per 90mins
- They have averaged 28.7 aerial duels per 90mins
- Teamfit shows a 78% match
- Genk does not have many options as a DM.
- They need a defensive midfielder who can recycle the ball effectively and is good in 1v1 duels.

Netherlands Eredivisie

Twente

- They have averaged 65.67 progressive passes per 90mins
- They have averaged 23.84 aerial duels per 90mins
- Teamfit shows a 78% match
- The club is currently short on defensive midfielders as one of the players has moved to another club and the other has retired.
- Yamane would be a good addition to starting 11

Utrecht

- They have averaged 59.47 progressive passes per 90mins
- They have averaged 38.41 aerial duels per 90mins
- Teamfit shows a 74% match
- One of the DM options for the club is 34 years old
- Yamane would be a good cover for Brouwers as he is young and has excellent capabilities in terms of his defensive work.

AZ

- They have averaged 62.99 progressive passes per 90mins
- They have averaged 32.33 aerial duels per 90mins
- Teamfit shows a 74% match
- AZ needs a backup option for Clasie who is 31 and his contract will be expiring next year
- Yamane will provide good competition to him and will be a valuable addition to the squad.

Turkey Super Lig

Istanbul Başakşehir

- They have averaged 61.14 progressive passes per 90mins
- They have averaged 22.81 aerial duels per 90mins
- Teamfit shows a 78% match
- Başakşehir is short in the DM department as one player is injured and the other is out of contract this summer.
- Yamane would be a solid option for the team to look at this summer.

Gaziantep

- They have averaged 63.69 progressive passes per 90mins
- They have averaged 26.36 aerial duels per 90mins
- Teamfit shows a 77% match
- One of the DM options for the club has not been offered a contract extension
- Yamane can be a good replacement for him as he is young and has excellent technical and defensive abilities

Antalyaspor

- They have averaged 62.65 progressive passes per 90mins
- They have averaged 33.92 aerial duels per 90mins
- Teamfit shows a 76% match
- The club can do with a young DM as one of their DM options is 31 years old.
- Yamane would be a perfect addition to the club this summer as he will bring a lot of attributes to the team

TFA